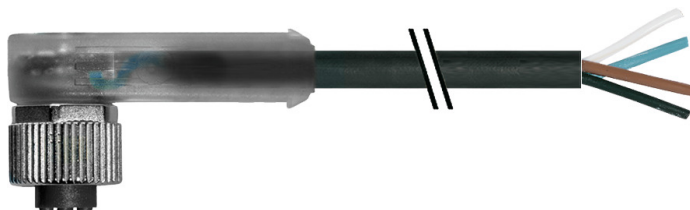

Vue d'ensemble

- M12, female, A-coded, 4-poles; PUR, 200 cm, free cable end
- Dragchain capable; suitable for robotics $\pm 180^\circ/\text{m}$
- Head A: IP65, IP66K, IP67
- Cable: good resistance against chemicals, flames, oils

Caractéristiques techniques

Side A		Cable	
Head A: Connection	M12	Number and diameter of wires	4x0,34
Head A: Angle cable outlet	90°	Length tolerance	+ 10 cm
Head A: Gender	Female	Cable length	200 cm
Head A: Coding	A	Acceleration (C-track)	max. 10 m/s ²
Head A: No. of poles	4	AWG	22
Head A: LED	Oui	Bending radius (fixed)	min. 5 × outer diameter
Head A: LED switching status	PNP	Torsion speed	max. 35 cycles/min
Head A: Width across flats	AF13	Bending radius (mobile)	min. 10 × outer diameter
Head A: Tightening torque	0,6 Nm	Cable type	3
Head A: Knurled nut material	Zinc-pressure die casting, surface Ni	Cable weight	approx. 36,3 g/m
Head A: Body color	Transparent	Conductor structure	42 × 0,1 mm
Head A: Gasket material	FKM	Cable diameter	4,5 mm ± 5%
Labeling sleeve side A	Yes	Conductor: Material	Copper, bare
Side B		External sheath: Material	PUR
Head B: Connection	Open-ended wires	Insulation: Material	PP
Labeling sleeve side B	Yes	No. of bending cycles (C-track)	approx. 10000000 Cycles
Cables		Nominal voltage	300 V
Cable length	200 cm	No. of torsion cycles	approx. 2000000 Cycles
Length tolerance	+ 10 cm	Paired stranding	No
Stripping length	20 mm	Single wire diameter	0,1 mm
Shielded	No	Cable: Test voltage	2,5 kV
Conductor structure	42 × 0,1 mm	Torsion stress in °	± 180 °/m
AWG	22	Total stranding	4 wires strand
External sheath: Material	PUR	Travel speed (C-track)	max. 3 m/s
External sheath: Color	Black	Traversing path (horizontal)	max. 10 m
Cable diameter	4,5 mm ± 5%	Wire cross section	0,34 mm ²
Wire cross section	0,34 mm ²	Wire processing	No
Cable		Wire diameter incl. isolation	1,25 mm ± 5%
External sheath: Shore hardness	90 ± 5 A	External sheath: Color	Black
Cable: Temperature range (mobile)	- 25 ...+ 80 °C	Données électriques	
Cable: Temperature range (fixed)	- 40 ...+ 80 °C	Operating voltage	24 V DC ± 25 %
Operating voltage (only UL listed)	30 V DC	Operating voltage (only UL listed)	30 V DC
Shielded	No	Nominal voltage	300 V
Bending radius (fixed)	22,5 mm	Contact resistance	max. 30 mOhm
Number of wires	4	Operating current per contact	max. 4 A

Caractéristiques techniques

Données mécaniques

Head A: Degree of protection	IP65, IP66K, IP67
Bending radius (mobile)	min. 10 × outer diameter
Bending radius (fixed)	min. 5 × outer diameter
No. of bending cycles (C-track)	approx. 10000000 Cycles
Torsion speed	max. 35 cycles/min
Torsion stress in °	± 180 °/m
No. of torsion cycles	approx. 2000000 Cycles
Acceleration (C-track)	max. 10 m/s ²
Travel speed (C-track)	max. 3 m/s

Conditions ambiantes

Temperature range (mobile)	- 25 ...+ 80 °C
Temperature range (fixed)	- 25 ...+ 80 °C
Cable: Temperature range (fixed)	- 40 ...+ 80 °C

Conditions ambiantes

Dragchain capable	Oui
Head A: Chemical resistance	No
Head A: Flame resistance	HB (UL 94)
Head A: Oil resistance	ASTM 1 oil, mineral oils, limited to hydraulic oils
Head A: Acid and alkali resistant	No
Head A: Pollution degree	3
Cable: Chemical resistance	Good (DIN EN 60811-404)
Cable: Flame resistance	Conform UL 1581 §1090 (H), CSA FT2, IEC 60332-2-2
Cable: Oil resistance	Good (DIN EN 60811-404)
Cable: Silicone-free	Oui

Commercial data

Eclass	27060311
--------	----------

Side A

Technical drawing

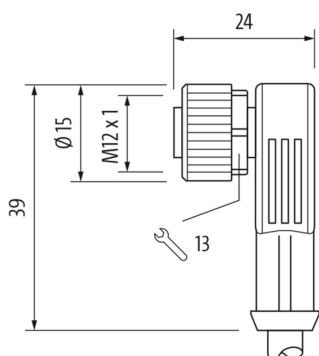

Side B

Technical drawing

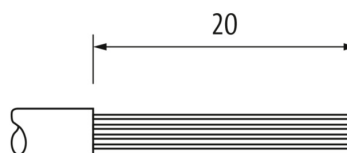

Coding



Schéma de raccordement



Dessin d'encombrement

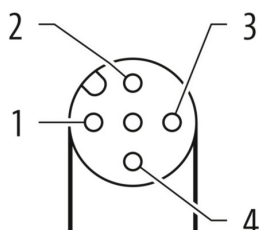
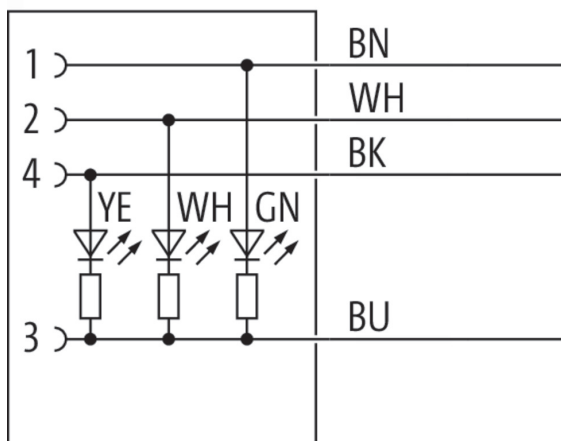