

Vue d'ensemble

- M12, male, L-coded; 5-poles; PUR, 500 cm, free cable end
- Dragchain capable; suitable for robotics $\pm 180^\circ/\text{m}$
- Head A: IP65, IP67
- Cable: good resistance against chemicals, flames, oils
- Halogen free

Caractéristiques techniques

Side A		Cable	
Head A: Connection	M12	Bending radius (fixed)	min. 7,5 × outer diameter
Head A: Angle cable outlet	90°	Torsion speed	max. 35 cycles/min
Head A: Gender	Male	Bending radius (mobile)	min. 10 × outer diameter
Head A: Coding	L	Cable type	3
Head A: No. of poles	5	Cable weight	approx. 129,8 g/m
Head A: LED	No	Conductor structure	84 × 0,15 mm
Head A: Width across flats	AF17	Cable diameter	8,7 mm \pm 5%
Head A: Tightening torque	0,6 Nm	Conductor: Material	Copper, bare
Head A: Knurled nut material	Zinc-pressure die casting, surface Ni	External sheath: Material	PUR
Head A: Body color	Black	Insulation: Material	PP
Labeling sleeve side A	Yes	No. of bending cycles (C-track)	approx. 500000 Cycles
Side B		Nominal voltage	1000 V AC
Head B: Connection	Open-ended wires	No. of torsion cycles	approx. 200000 Cycles
Labeling sleeve side B	Yes	Paired stranding	No
Cables		Single wire diameter	0,15 mm
Cable length	500 cm	Cable: Test voltage	10 kV
Length tolerance	$\pm 7,5$ cm	Torsion stress in °	$\pm 180^\circ/\text{m}$
Stripping length	100 mm	Total stranding	5 wires strand around core-filler
Shielded	No	Travel speed (C-track)	max. 3,3 m/s
Conductor structure	84 × 0,15 mm	Traversing path (horizontal)	max. 5 m
AWG	16	Wire cross section	1,5 mm ²
External sheath: Material	PUR	Wire processing	No
External sheath: Color	Black	Wire diameter incl. isolation	2,3 mm \pm 5%
Cable diameter	8,7 mm \pm 5%	External sheath: Color	Black
Wire cross section	1,5 mm ²	Données électriques	
Cable		Operating voltage	max. 63 V DC
Cable: Temperature range (mobile)	- 20 ... + 80 °C	Nominal voltage	1000 V AC
Cable: Temperature range (fixed)	- 50 ... + 80 °C	Contact resistance	max. 30 mOhm
Shielded	No	Operating current per contact	max. 12 A
Bending radius (fixed)	65,25 mm	Données mécaniques	
Number of wires	5	Head A: Degree of protection	IP65, IP67
Number and diameter of wires	5x1,5	Bending radius (mobile)	min. 10 × outer diameter
Length tolerance	$\pm 7,5$ cm	Bending radius (fixed)	min. 7,5 × outer diameter
Cable length	500 cm	No. of bending cycles (C-track)	approx. 500000 Cycles
Acceleration (C-track)	max. 5 m/s ²	Torsion speed	max. 35 cycles/min
AWG	16	Torsion stress in °	$\pm 180^\circ/\text{m}$

Caractéristiques techniques

Données mécaniques

No. of torsion cycles	approx. 2000000 Cycles
Acceleration (C-track)	max. 5 m/s ²
Travel speed (C-track)	max. 3,3 m/s

Conditions ambiantes

Temperature range (mobile)	- 20 ...+ 80 °C
Temperature range (fixed)	- 25 ...+ 80 °C
Cable: Temperature range (fixed)	- 50 ...+ 80 °C
Dragchain capable	Oui
Head A: Chemical resistance	No

Conditions ambiantes

Head A: Flame resistance	V-2 (UL 94)
Head A: Acid and alkali resistant	No
Head A: Pollution degree	3
Cable: Chemical resistance	Good (DIN EN 60811-404)
Cable: Flame resistance	Conform UL 1581 VW-1, CSA FT1, IEC 60332-1, IEC 60332-2-2
Cable: Oil resistance	Good (DIN EN 60811-404)
Cable: Silicone-free	Oui

Commercial data

Eclass	27060311
--------	----------

Side A

Technical drawing

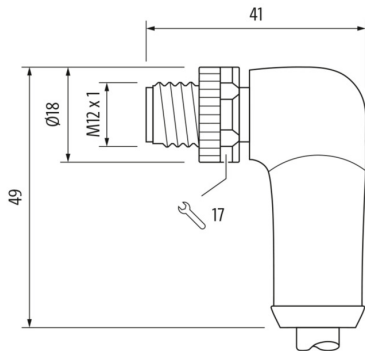

Side B

Technical drawing

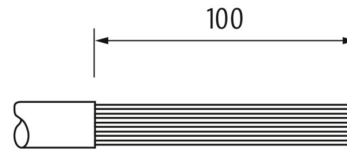

Coding



Schéma de raccordement



Dessin d'encombrement

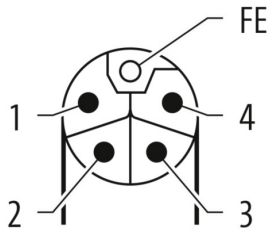
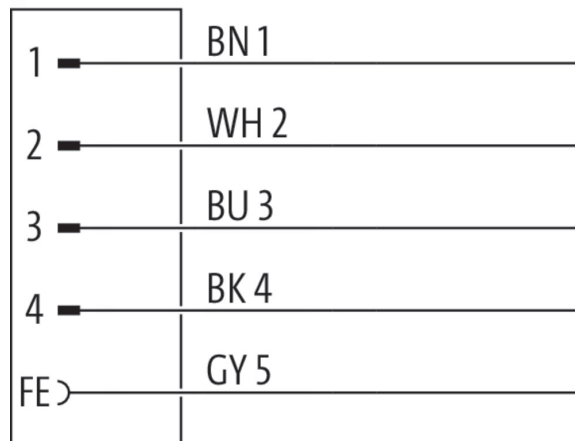