



Operating Manual

CM50I.EC

IO-Link Master with EtherCAT

EN-US

1 About this document

1.1 Purpose and scope of application

This document instructs the technical staff of the machine manufacturer or machine operator on the safe use of the described devices.

It does not include instructions on the safe use of the machine in which the devices are integrated. Information on this is found in the operating manual of the machine.

- Read this chapter carefully before you start working with the device.
- Study the documentation carefully before device commissioning.
- Store the manual in a place that is accessible to all users at all times for the entire service life of the device.

Understanding the present manual requires general knowledge about automation technology. In addition, planning and using automation systems requires technical knowledge which is not included in this manual.

1.2 Applicable documents



- Available for download at www.baumer.com:
 - Instruction manual
 - Data sheet
 - Device description file
 - EU Declaration of Conformity
 - Certificates and Approvals
- Attached to product:
 - General information sheet (11042373)

1.3 Labels in this manual

Identifier	Usage	Example
<i>Dialog element</i>	Indicates dialog elements.	Click the OK button.
<i>Unique name</i>	Indicates the names of products, files, etc.	<i>Internet Explorer</i> is not supported in any version.
Code	Indicates entries.	Enter the following IP address: 192.168.0.250

1.4 Warnings in this manual

Warnings draw attention to potential personal injury or material damage. The warnings in this manual indicate different hazard levels:

Symbol	Warning term	Explanation
	DANGER	Indicates an imminent potential danger with high risk of death or serious personal injury if not being avoided.
	WARNING	Indicates potential danger with medium risk of death or (serious) personal injury if not being avoided.
	CAUTION	Indicates a danger with low risk, which could lead to light or medium injury if not avoided.
	NOTE	Indicates a warning of material damage.
	INFO	Indicates practical information and tips that enable optimal use of the devices.

1.5 Scope of delivery

Delivery includes:

- 1 x CM50I device
- 1 x instruction manual - multilingual
- 15 x designation label

1.6 Trademarks

The present documentation uses the trademarks of the following companies and institutions:

EtherCAT® und TwinCAT®
IO-Link

Registered trademarks of Beckhoff Automation GmbH
c/o PROFIBUS User Organisation e.V. (PNO)

1.7 Software-Tools

Applied software
<i>Baumer Sensor Suite (BSS)</i>

1.8 Specifications

Specification	Link
<i>TwinCAT</i> Version 3.1	www.beckhoff.com
<i>IO-Link</i> Version 1.1.2 of 07.2013	www.io-link.com



INFO

The features of IO-Link specification V 1.1.3 are supported.

2 General information

Intended use

This product is a precision device and serves the detection of items, objects, or physical measurement variables and the preparation or provision of measured values as electric variables for the higher-level system.

Unless specifically labeled, this product may not be used in explosive environments.

Commissioning

Assembly, installation, and calibration of this product may only be performed by a specialist.

Installation

Only use the fasteners and fastener accessories intended for this product for installation. Outputs not in use must not be wired. Unused wires of cable outputs must be insulated. Do not go below the permissible cable bending radii. Disconnect the system from power before the product is electrically connected. Use shielded cables to prevent electro-magnetic interference. If the customer assembles plug connections on shielded cables, then EMC-version plug connections should be used and the cable shield must be connected to the plug housing across a large surface area.

Disposal (environmental protection)



Used electrical and electronic devices may not be disposed of in household waste. The product contains valuable raw materials that can be recycled. Therefore dispose of this product at the appropriate collection point. For additional information visit www.baumer.com.

3 Safety

3.1 General safety instructions



⚠ DANGER

High electrical voltage in the machine/system.

Death or severe injuries resulting from electric shock.

- a) While working on the machine/devices, comply with the five safety rules of electrical engineering.

Protection of persons and material assets

- According to DIN VDE 0105-100 - Operation of electrical systems - Part 100: General definitions

The 5 Safety Rules

Protect against *high electrical voltage*

1. Switch off the device.
2. Secure against unwanted switchon.
3. Ensure that each pole is not live respectively under voltage.
4. Grounding and short-circuiting.
5. Cover or block neighboring parts under voltage.

Qualified personnel

The appliance may only be installed, commissioned and operated by qualified personnel who have received safety training.

Qualified means fulfilling the following requirements:

- the personnel underwent suitable training in electrical engineering,
- the personnel is familiar with the safety standards which are common practice in automation engineering,
- the personnel has access to the Operating instructions and the present Instruction Manual,
- are familiar with the safety standards of automation technology,
- the personnel is familiar with the related and applicable basic and technical standards.

Intended use of the device

- During project engineering, installation, commissioning, operation, and testing of the device comply with the existing regulations on accident prevention as well as health and safety at work.
- Check material resistance against aggressive media.



INFO

Any manipulation/modification of hardware and software only qualified *Baumer* personnel, except for firmware updates.

**INFO**

Only use a power unit of max. 60 V DC respectively 25 V AC in single fault condition. Power supply must comply with *SELV* or *PELV*.

Protective measures by the machine operator

- Follow the instructions in this manual.
- Observe the specifications and operating instructions of each connected component.

4 Description

4.1 Device

CM50I.EC is a compact *EtherCAT* device in a plastic housing with IP67 protection.

Feature	Description
Connection	For <i>EtherCAT</i> connection there are 2 x M12 slots (D-coded).
Supply	Supply is via M12 power (L-coded 5-pin) and looped to the next.
IO-Link	The device features also 8 x M12 IO-Link master slots (coded). IO-Link masters (Pin4 C/Q) enable individual parameterization, either in IO-Link or in SIO mode (DI, DO). Additional digital inputs and outputs, as well as a permanent 24 V supply, are available for each slot (Pin2 I/Q).
General information	<ul style="list-style-type: none"> ▪ EtherCAT: AoE, CoE, EoE, FoE ▪ Protection IP67 ▪ Tested on vibration and shocks



4.1.1 Product name nomenclature

The nomenclature is based on a scheme indicating the product functionality.

CM50I	Product family
EC	Function <ul style="list-style-type: none"> ▪ EtherCAT

4.1.2 Device structure

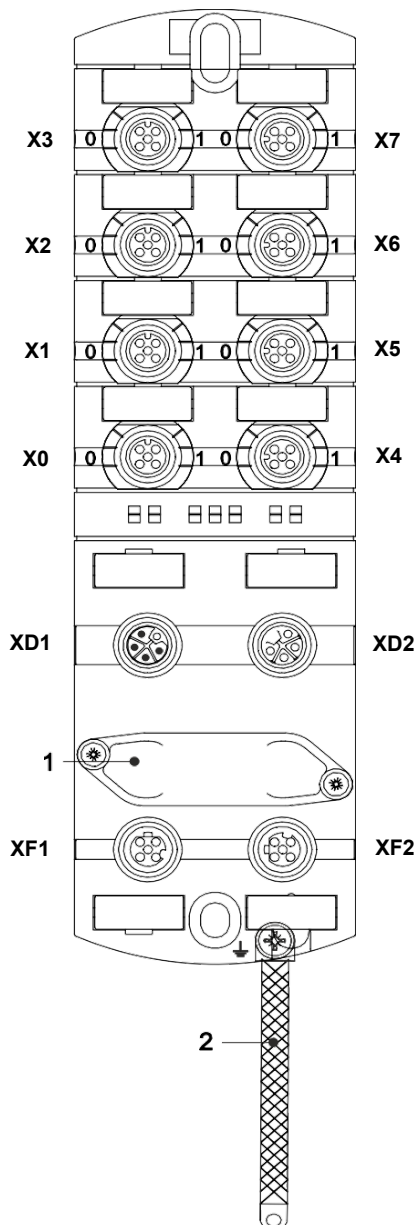

X0 ... X7 Digital I/O or IO-Link

M12 A-coded

0 Channel corresponds to pin 4

1 Channel corresponds to pin 2

Examples:

Channel **02** = **Pin 4** port X2

Channel **16** = **Pin 2** port X6

XD1 Power supply POWER IN, M12 L-coded 5-pin

XD2 Power supply POWER OUT, M12 L-coded 5-pin

1 Rotary switch

XF1 EtherCAT IN, Port 1, M12 D-coded

XF2 EtherCAT OUT, Port 2, M12 D-coded

2 Ground strap for functional ground

4.1.3 Pin assignment

M12 female connector A-encoding

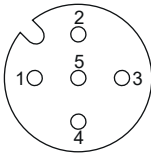
X0 ... X7		
	Pin 1	L+
	Pin 2	DI
	Pin 3	L-
	Pin 4	C/Q
	Pin 5	n.a.

M12 male/female connector, POWER IN/OUT

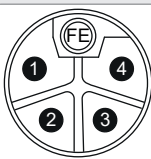
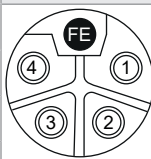
XD1			XD2
	Pin 1	US+	
	Pin 2	UA-	
	Pin 3	US-	
	Pin 4	UA+	
	Pin 5	FE	

M12 female connector D-encoding port 1 / port 2

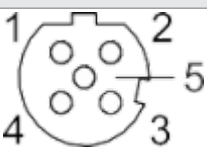
XF1 / XF2		
	Pin 1	Tx +
	Pin 2	Rx +
	Pin 3	Tx -
	Pin 4	Rx -
	Pin 5	n.a.

4.1.4 Display elements

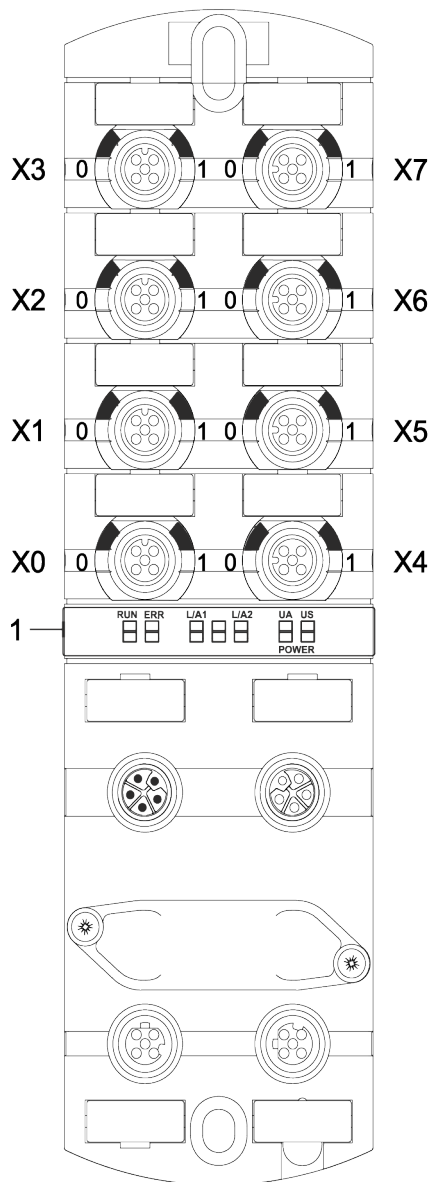

X0 ... X7 LED digital I/O or IO-Link

- 1 LED RUN
- LED ERR
- LED L/A1
- LED L/A2
- LED POWER UA
- LED POWER US

Also see about this

[LED indicator \[▶ 89\]](#)

4.2 EtherCat

4.2.1 EtherCAT communication

In automation technology, fieldbus systems have been established for many years. However, the strong demand for ever higher speeds brought the technology to its technical limits and new solutions had to be found.

Today, office-known Ethernet is present everywhere and at 100 MBit/s also very fast. According to the cabling and access rights used, this type of Ethernet is not real-time capable. *EtherCAT* remedied the problem.

EtherCAT®

The following applies to EtherCAT®:

- *EtherCAT* is a registered trademark and patented technology, licensed by Beckhoff Automation GmbH, Germany.
- *EtherCAT* means *Ethernet for Controller and Automation Technology*. It was originally developed by the company Beckhoff Automation GmbH and is now supported and further developed by EtherCAT Technology Group (ETG). ETG is the world's largest international user and manufacturer association for Industrial Ethernet.
- *EtherCAT* is an open, IEC- standardized fieldbus based on Ethernet. It fulfills the user profile for industrial real-time systems.
- In contrast to classic Ethernet, *EtherCAT* communication provides I/O data exchange at 100 Mbit/s in full duplex mode, while the telegram is passing the *EtherCAT* slaves. As a telegram reaches the data of many subscribers in the send and receive direction in this way, *EtherCAT* has a user data rate of over 90 %.
- The process data optimized *EtherCAT* is transmitted straight in the Ethernet telegram. This in turn may consist of several sub-telegrams, each providing a section for saving the process image.

Transmission medium

EtherCAT utilizes Ethernet as transmission medium. Standard CAT5 cables are used. Cable lengths of up to 100 m between 2 users are feasible.

EtherCAT networks may only integrate *EtherCAT* components. Related supporting *EtherCAT* components are required for implementing topologies that deviate from the line structure.

Network hubs cannot be used.

4.3 IO-Link

IO-Link defines a standard where smart devices at sensor and actuator level connect to automation systems.

Communication takes place between the IO-Link master and one or more IO- Link peripheral devices. Each port connects a single device. IO-Link is a point-to-point communication standard, not a fieldbus system.

The IO-Link Master acts as interface between the superior fieldbus level and the IO-Link devices.

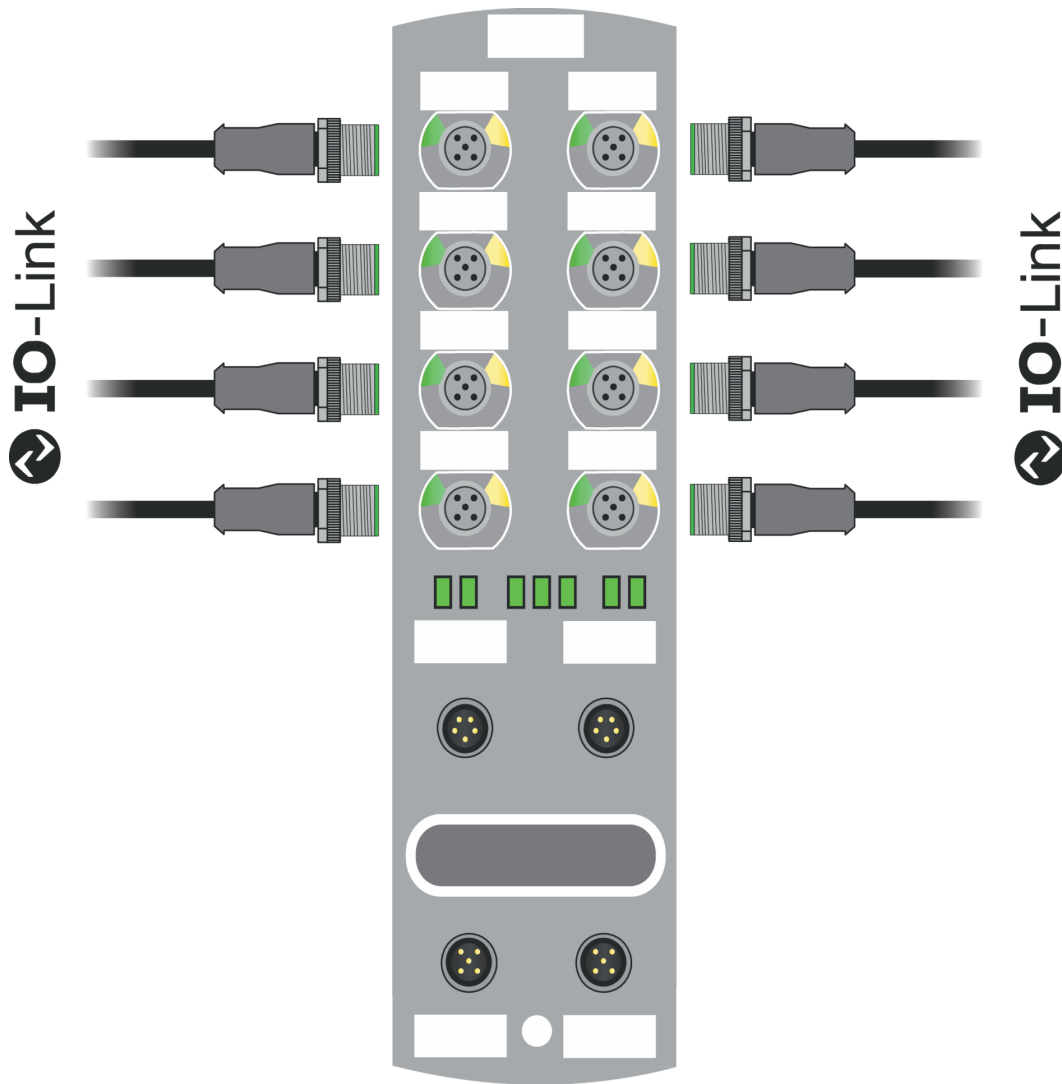

III. 1: IO-Link

IO-Link-Mode (IOL)

The IO-Link communication (C/Q) is assigned to pin 4, for connection and use of an IOL device.

Acyclic data may serve for writing device parameters of IO-Link devices or for reading parameters, measured values and diagnostic data from IO-Link devices.

IO-Link CALL

The following tasks can be performed:

- Parameterization/configuration of IO-Link devices during operation.
- Diagnostic of IO-Link devices by reading diagnostic parameters.
- Execute IO-Link port functions.
- Back-up/recovery of IO-Link device parameters.

IO-Link device data are uniquely addressed via index and sub-index.

Such data can be accessed with the so-called IOL CALL block. Usually, it is provided as data handling block by the PLC manufacturer.

4.3.1 Data storage



INFO

Data storage is only available for IO-Link devices compliant to IO-Link version V1.1 and higher.

- Data storage allows for replacing IO-Link devices without the need for new configuration.
- IO-Link master and IO-Link device save the parameterization of the previous device.
- Data storage synchronizes the data memories of IO-Link master and IO-Link device.
- Once the IO-Link device has been replaced, the master will write the saved parameters into the new device, provided data storage is enabled in the IO-Link Master.
- This allows for application restart without parameterization from scratch.
- When replacing the IO-Link master, the new Master will read parameterization out of the IO-Link device and save it. Doing so requires the data storage option “Save and restore” being enabled.
- This allows for application restart without parameterization from scratch.
- For data storage application, vendor ID and device ID of the connected IO-Link device must be entered in the validation settings of each IO-Link master port.
- The IO-Link port mode must be set to “Manual”.
- To store the modified IO-Link device parameters again in the master, device parameterization must be done via block parameterization.
 - After this, the device transmits an upload request to the Master.
 - Block parameterization can be carried out via the IO-Link device tool in the “Parameter” window and with the “Block Write Mode”.
 - Optionally, block parameterization can be done by device parameter writing via web server or PLC block, e.g. Siemens IOL_Call.
 - Always terminate block parameterization with command "Parameter Download Store" ISDU Index 0x02 Subindex 0 Value 05.
- In validation/backup mode “no Device check”, the saved device parameter content in the IO-Link master is deleted.

4.4 Simple Network Management Protocol (SNMP)

SNMP is a simplified network protocol with varied objects for monitoring the following:

1. Network components,
2. Remote control and configuration of network components,
3. Error detection and error messaging.

TCP/IP based network components relate to standard RFC 1213. This standard describes the access options and structure of the corresponding objects.

4.5 Industrial Internet of Things (IIoT)

The device supports the following IIoT functions for industrial communication: *JSONMQTT* and *OPC UA*.

5 Technical data

5.1 Electrical Data

Bus data		
Fieldbus protocol		EtherCAT
Connection		4-pin M12, D- coded
Transmission rate		100 Mbit/s
Addressing		Auto-Increment, Fixed-Position
Specification		ETG.5001.6220 S
Supported protocol	ADS over EtherCAT	AoE
	CANopen over EtherCAT	CoE
	Ethernet over EtherCAT	EoE
	File access over EtherCAT	FoE
Diagnostic function	EtherCAT state machine	ESM
	Emergency messaging	EMCY
SYNC-Manager		4
FMMU		8
OPC UA-Server		
OPC UA-Server	According to <i>IO-Link Companion Specification</i>	Yes
Transport		UA TCP, UA Secure Conversation, UA Binary Encoding
Server profile		Micro Embedded Device
Protocol		OPC UA TCP
User access	Read-only Read and write	Anonymous Username/password
Number of sessions		2
Number of subscriptions per session		2
Number of monitored items per session		20
Minimum release interval		100 ms
Maximum number of sessions/clients		5
Data encoding		UA binary
Energy monitoring	Current and voltage	Yes
Temperature monitoring		Yes
IO-Link		
Operating voltage IO-Link devices		24 V □
Voltage range IO-Link devices		20 ... 30 V □

IO-Link		
Transmission rate		COM1 / COM2 / COM3
Standardized Master Interface (SMI)		According to IO-Link Specification V1.1.3
Transmission rate recognition		Automatic
Supply		
Operating voltage US		24 V □
Voltage range US		18 ... 30 V □
	When using IO-Link	20.3 ... 30 V □
Operating voltage UA		24 V □
Voltage range UA		18 ... 30 V □
Sensor current US	≤40 °C (see Derating)	≤16 A
Actuator current UA	≤40 °C (see Derating)	≤16 A
Current consumption	At idle	≤0,18 A
Protection against reverse polarization for US and UA		Yes
Reverse polarity protection		Yes
Connection		5-pin M12, L-coded
Conductor cross-section	Current per supply ≤12 A	≥1.5 mm ²
	Current per supply >12 A	≥2.5 mm ²
Input (DI)		
Sensor supply +	Per port, ≤40 °C (see Derating)	≤2 A load Automatic start
Total current sensor supply	≤40 °C (see Derating)	≤10 A
Filter time		0 ... 15 ms + t _{cycle} , adjustable
Delay time at changed signal		2 ... 5 ms
Input characteristic	EN 61131-2	Type 1 + Type 3
Short-circuit protection sensor supply		MOSFET with current measurement
Connection		5-pin M12, A-coded
Cable cross-section M12		≤0.75 mm ²
Cable length		≤30 m
Total current	Per port	≤4 A
Output (DO)		
Output current DO (UA)	Per pin, ≤40 °C (see Derating)	≤2 A
Total current outputs	≤40 °C (see Derating)	≤10 A
Switching frequency		≤50 Hz
Short-circuit protection actuator		MOSFET with current measurement
Connection		5-pin M12, A-coded
Cable cross-section M12		≤0.75 mm ²
Cable length		≤30 m

Output (DO)		
Total current	Per port	≤4 A

Derating sensor current US/ actuator current UA

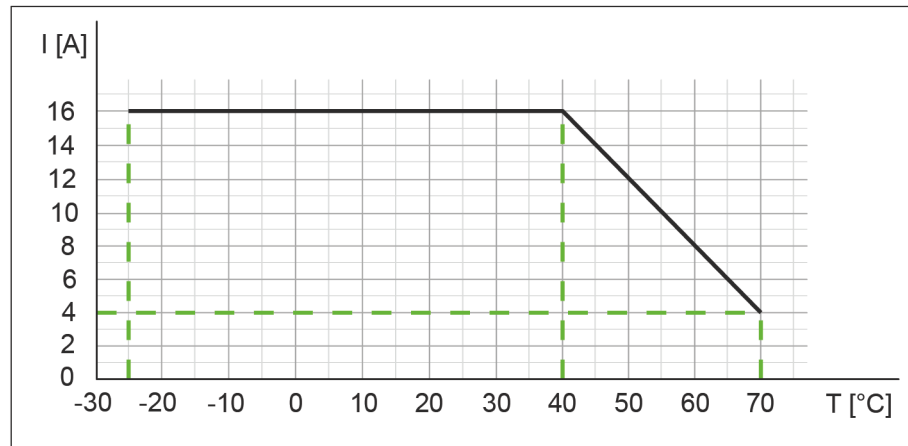

III. 2: Derating sensor current US/ actuator current UA

Derating total current, sensor power supplies/outputs total current

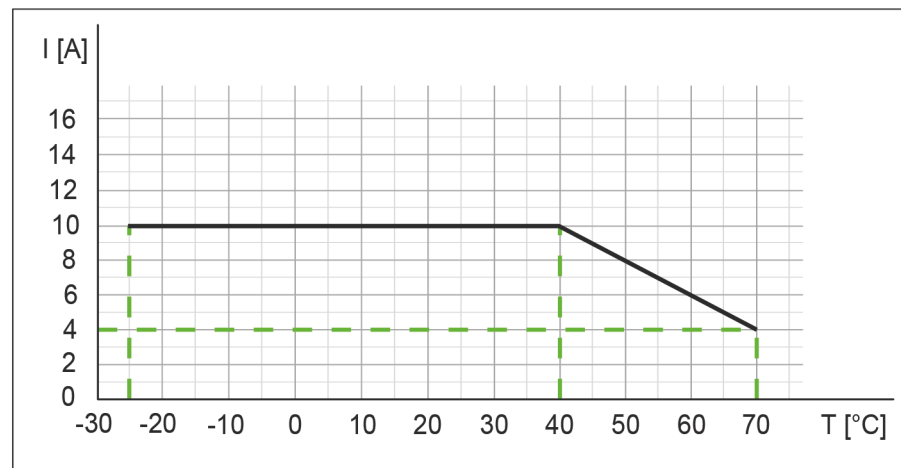

III. 3: Derating total current, sensor power supplies and total current, outputs

Derating current per sensor supply/output

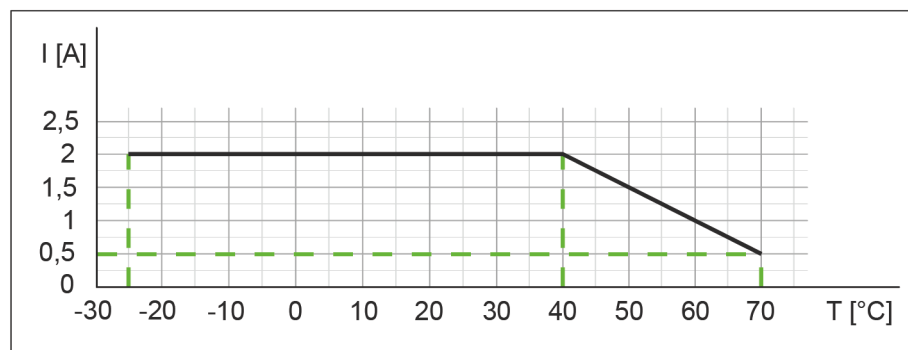

III. 4: Derating current per sensor power supply and output

5.2 Ambient conditions

Climate		
Operating temperature		-25 °C ... +70 °C
Storage temperature	Ensure acclimatization for commissioning	-25 °C ... +85 °C
Transport temperature	Ensure acclimatization for commissioning	-25 °C ... +85 °C
Relative humidity		≤95 %
Installation height	Above sea level	≤3000 m
Mechanical		
Oscillation test	EN 60068 Part 2-6	10 ... 58 Hz, amplitude 0.35 mm, 58 ... 150 Hz; 20 g
Shock test	EN 60068 Part 2-27	50 g for 11 ms
Electrical safety		
Protection	EN 60529	IP67
Protection rating	Using a SELV- or PELV-power supply	III
Level of contamination		2
EMC emission		
Radiated interference E-field housing enclosure	EN 55016-2-3	Compliant
EMC-immunity		
Electrostatic discharge (ESD)	EN 61000-4-2	Compliant
Electromagnetic RF-fields	EN 61000-4-3	Compliant
Fast transient burst	EN 61000-4-4	Compliant
Shock tension surge	EN 61000-4-5	Compliant
Conducted RF-fields	EN 61000-4-6	Compliant
Voltage dips	EN 61000-4-11	Compliant

5.3 Protection

Device protection		
Overvoltage protection		Yes
Overload protection device supply	To be ensured by load circuit monitoring	Yes
Inverse-polarity protection device supply		Yes
Short-circuit protection sensor supply		Electronically
Short-circuit protection output		Electronically
Protective circuit input	Internal	Suppressor diode

5.4 Mechanical data

Material data		
Housing material		Plastic
Mounting data		
Weight	Net	470 g
Dimensions	L x W x H	225,4 x 63 x 36 mm

5.5 Conformity, Approvals

Conformity, Approvals		
Product standard	EN 61131-2 Programmable Logic Controllers Part 2	Compliant
CE	2014/30/EU 2011/65/EU	Compliant
UKCA		Compliant
EMC	2014/30/EU	Compliant
REACH	No. 1907/2006	SVHC List
WEEE	2012/19/EU	Compliant
ULus		E201820
RoHS	2011/65/EU & 2015/863	Exception 6c&7a
China RoHS	SJ/T 11364-2014	25 EPUP

Hazardous substance (有害物質)							
	Part Name	Lead	Mercury	Cadmium	Hexavalent	Polybrominated	Polybrominated
	零件名稱	(Pb) 鉛	(Hg) 汞	(Cd) 鎘	Chromium (Cr (VI)) 六价铬	biphenyls (PBB) 多溴联苯	diphenyl ethers (PBDE) 多溴联苯醚
	Component part PCB 组件部分 印刷电路板	X	O	O	O	O	O
	Connection Terminal/ Screws 接线端子 / 拧	X	O	O	O	O	O
<p>O: Indicates that the content of the harmful substance in all homogeneous materials of the component part is below the limit defined in GB/T 26572.</p> <p>O: 表明該有害物質在組成部分的所有均質材料的含量低於按GB/ T26572定義的限制。</p> <p>X: Indicates that the content of the harmful substance in at least one homogeneous material of the component part exceeds the limit defined in GB/T 26572.</p> <p>X: 表示該有害物質在組成部分中的至少一個均質材料的含量超過按GB / T26572定義的限制。</p>							

6 Installation

6.1 Requirements

Installation requirements:

- Even mounting surface to avoid mechanical tension.
- Provide proper grounding.
- Suitable installation site in terms of vibration and shock load, temperature and humidity (see Technical data).
- Protected site to prevent connection cables from being torn off accidentally.

6.2 Dimensions

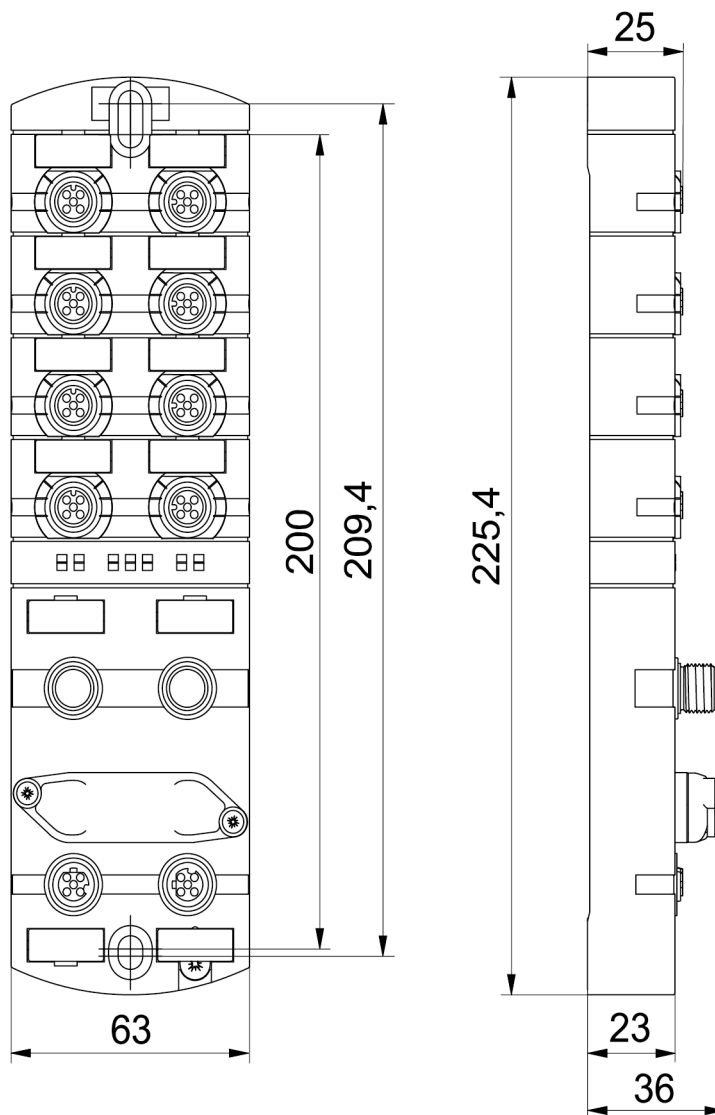

/// 5: Dimensions in mm

6.3 Mounting distance

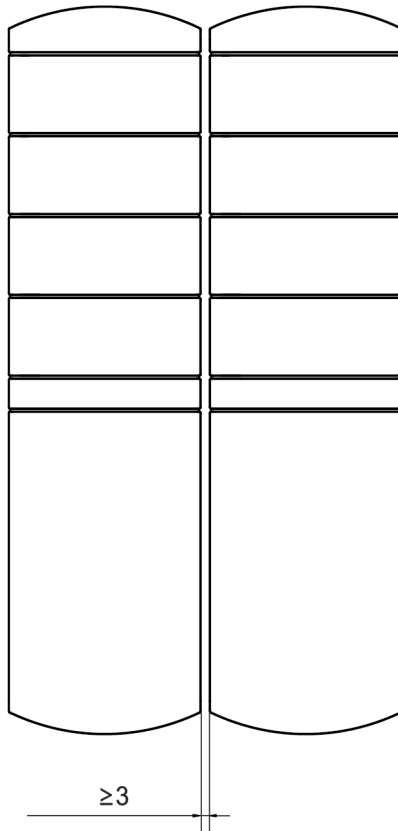

III. 6: Distance in mm

**INFO**

For proper installation and improved heat dissipation, we recommend maintaining a minimum distance of 3 mm when installing *CM50I*.

**INFO**

Minimum distance of 50 mm required where using angled connectors.

6.4 Mounting the device



⚠ WARNING

Material damage due to incorrect installation.

Use fastening screws that are appropriate for the mounting surface.

- a) Fastening screws and tightening torques depend on mounting surface.
- b) Tighten the screws carefully. Observe the specified tightening torques.



⚠ WARNING

Material damage through improper use.

Do not use the devices as climbing aids. Devices may come off by improper use or might be damaged.

- a) Install the device in such a way that it cannot be used as climbing aid.

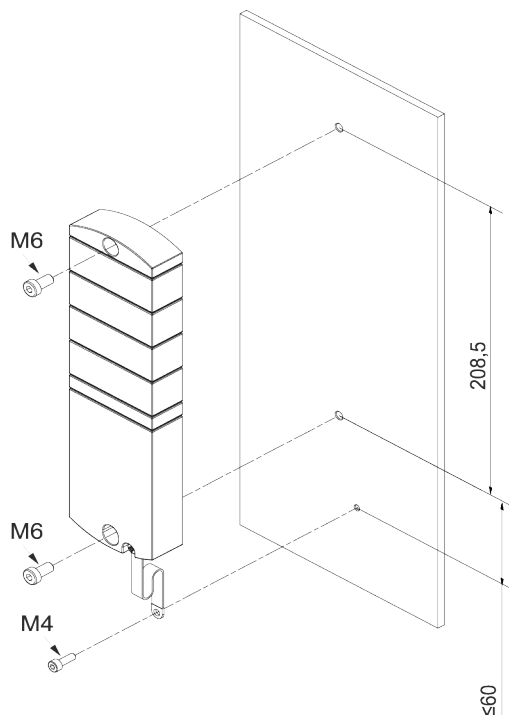

Ill. 7: Fasten the device. Dimensions in mm (illustration similar)

M6	3 Nm		Art.-No. 7000-98001-0000000
----	------	---	--------------------------------

When mounting the device, observe the order indicated below:

- a) Slightly tighten the top M6 screw.
- b) Align the housing.
- c) Slightly tighten the lower M6 screw.
- d) Tighten both M6 screws to the specified torque.
- e) *Device grounding*: Attach grounding strap (see [Functional ground \[▶ 22\]](#)).



INFO

The screws and grounding strap of the illustration are not included in the delivery.

6.4.1 Functional ground



INFO

Use a conductive screw to attach the grounding strap.

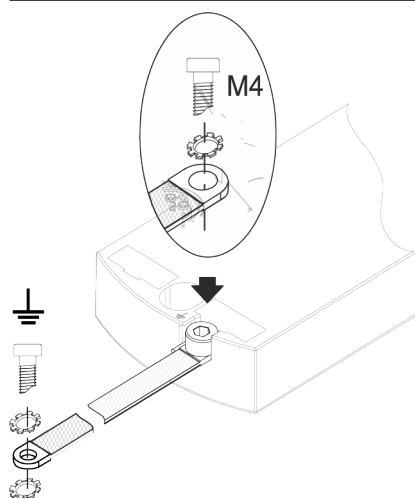

III. 8: Attach the grounding strap

Tool

- ○ M4
- ◆ Tighten the screw at 1.2 Nm \pm 0.1 Nm.



INFO

The screws and grounding strap of the illustration are not included in the delivery. The grounding strap is available at the Baumer Website <http://baumer.com>.

Also see about this

[Accessories \[▶ 116\]](#)

6.4.2 Addressing lid

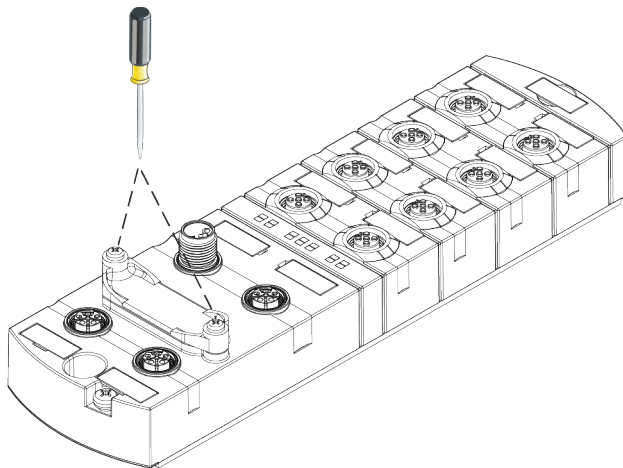

///. 9: Attaching the addressing lid

Tool

- ● M3

Instruction:

- ◆ Tighten the screws at $0.8 \text{ Nm} \pm 0.1 \text{ Nm}$ fest.

7 Installation

7.1 Electrical installation of the device

DANGER

High electrical voltage in the machine/system.

Death or severe injuries resulting from electric shock.

- a) While working on the machine/devices, comply with the five safety rules of electrical engineering.

Protection of persons and material assets

- In accordance with *DIN VDE 0105-100 - Operation of electrical installations - Part 100: General requirements*

WARNING

Risk of fire due to short circuit.

Supply lines and/or devices may short circuit when damaged causing overheating and fire.

- a) Ensure smart current monitoring or fuse
The fuse must be able to hold max. 9 A.

CAUTION

Loss of function due to improper installation.

Failure to observe may result in personal injury and/or damage to property.

- a) Only use cables and accessories compliant to the requirements and relevant regulations for safety, electromagnetic compatibility and, if required, telecommunication end devices and specifications.



CAUTION

Hot surface.

Minor personal injuries and damage to the device when contacting hot surfaces.

- a) Wear suitable isolating gloves.
- b) Only use connection cables that meet thermal requirements.

CAUTION

Damage to machine/system by improper voltage on/off.

Switching on the device by separate actuator and sensor voltage, the functions of the digital inputs and outputs cannot be guaranteed.

- a) For device switch-on observe the following order:

- a) Switch on sensor voltage.
- b) Switch on actuator voltage.



INFO

Only use a power unit capable of limiting voltage to max. 60 VDC resp. 25 AC at the occurrence of error. Power supply must comply with SELV or PELV.

7.1.1 Rotary switch settings



INFO

Factory defaults: Rotary switch position is **000**.



INFO

An unambiguous and unique Device ID address must be assigned to each user in the network.

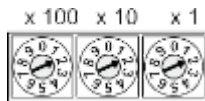

Address range 1 ... 999

x1	Rotary switch (units)
x10	Rotary switch (tens)
x100	Rotary switch (hundreds)

Tab. 1: Rotary switch for addressing

Using *Explicit Device ID* requires setting the Device IDs.

Position/ area	Web server	JSON	OPC UA	MTQQ	Description	
0	– *	– *	– *	– *	Standard operation	<i>EtherCAT ID</i> can be assigned via mailbox (Explicit Device ID).
1 ... 99	– *	– *	– *	– *	<i>EtherCAT ID</i>	<i>EtherCAT ID</i> is set to value of rotary switch.
100 ... 910	– *	– *	– *	– *	Reserved *	
911	Disabled	Disabled	Disabled	Disabled	Secure Mode	Fieldbus communication in standard operation
912	– *	Disabled	Disabled	Disabled	IIoT mode disabled	
913	Disabled	Disabled	– *	– *	Web server and JSON disabled	
914	Enabled	Enabled	Enabled	Enabled	Enables all IIoT protocols and web server.	
915-978	– *	– *	– *	– *	Reserved	
979	Enabled	Enabled	enabled (up to FWV1.05) disabled (FWV1.06 and later)	enabled (up to FWV1.05) dis-abled(FW V1.06 and later)	Restore default	Sequence of actions only for this rotary switch position: <ol style="list-style-type: none"> 1. Disconnect device from power supply. 2. Set switch to position 979. 3. Connect device to power supply. 4. Wait until reset is completed. 5. Disconnect device from power supply. <p><i>ST LED flashing green: Device is performing reset.</i></p> <p><i>ST LED is on green continuous: Reset completed.</i></p>

Position/ area	Web server	JSON	OPC UA	MTQQ	Description
					6. Set switch to position 000 or any other required. 7. Connect device to power supply.
980-999	– *	– *	– *	– *	Reserved *

* Last protocol setting is retained.



INFO

Reserved switch positions do not enable fieldbus communication, see [LED indicator \[▶ 89\]](#).

Service settings

Switch positions 911, 912 and 913 disable the device services marked in the "set address" matrix. With these settings, the switching behaviour of the device is according to the previous address configuration without limiting any functions, except the services disabled by this switch position. The services disabled by doing so could not be re-enabled in any other way, e.g. via the control's configuration parameters.

Switch position 914 will enable all services again. Again, the device functionalities are not limited.

1. Connect device to power supply.
2. Disconnect supply.
3. Set original address.



INFO

Rotary switch values are only re-adopted after a power reset!

Setting the address

Setting the address

1. Disconnect device from supply.
2. Remove addressing lid.
3. Set an address which is unique.
4. Fasten addressing lid again.
5. Connect device to power supply.



INFO

For appropriate tightening torque see [Addressing lid \[▶ 23\]](#).

7.1.2 Sensors and actuators

Connection of M12 female connector

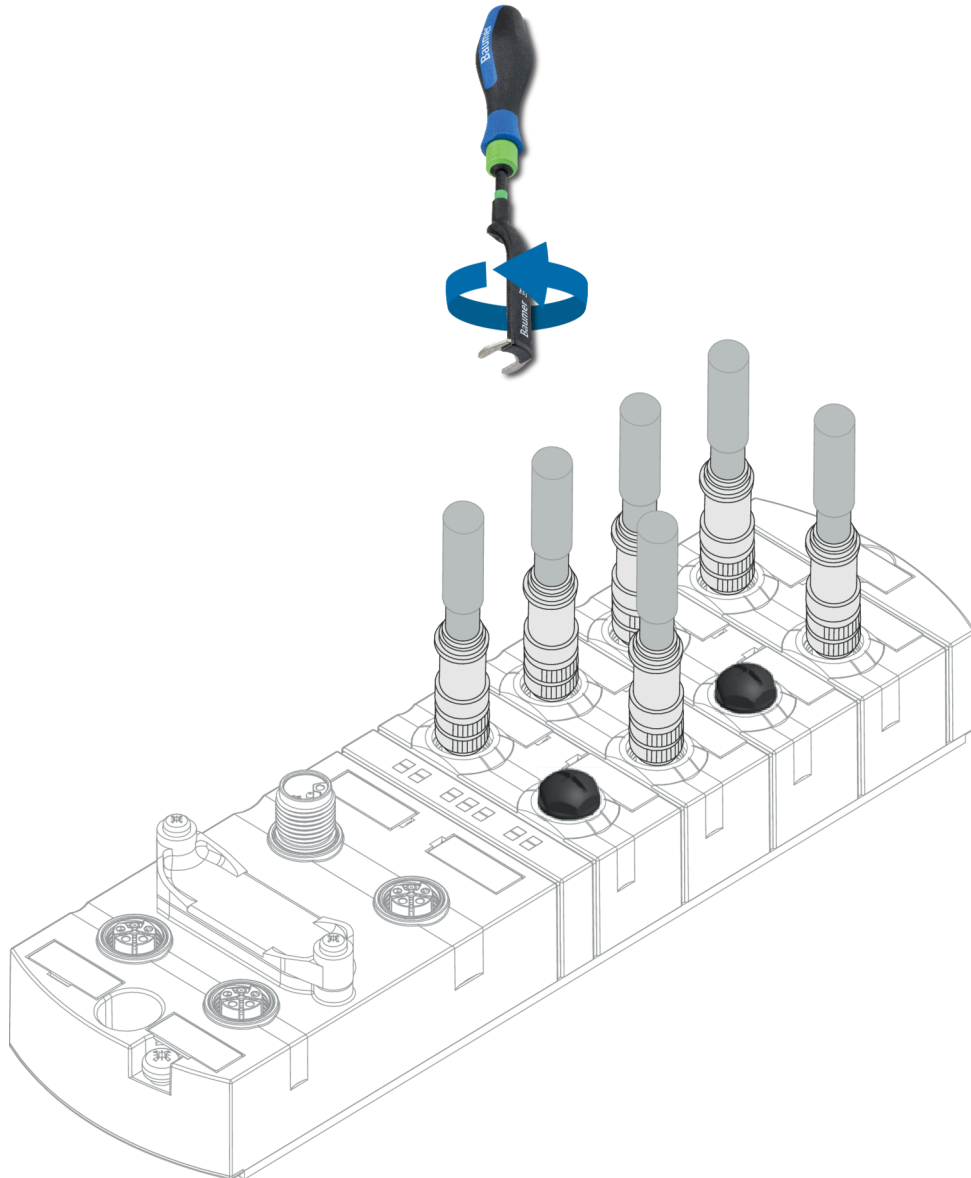
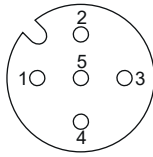

III. 10: Example of M12 connection inputs and outputs

M12	0.6 Nm		Art.-No. 7000-99102-000000
-----	--------	--	-------------------------------

**INFO**

Feeding external ground via M12 female connectors may lead to errors.

- a) Do not feed external ground into the device via the M12 female connectors.

**INFO**

Maximum length of sensor and actuator cables is limited to 30 m.

Sensor supply**Important:**

- Sensors supply is via **pin 1** (24 V) and **pin 3** (0 V) of the M12 female connectors.
- The maximum permissible current for supplying the sensors is **2 A** per M12 socket.
- In the event of overcurrent or short circuit, **disconnect** supply cable resp. sensor from the M12 female connector.

Supported IO-Link communication

The device supports IO-Link communication at the following rates:

- 4.800 Baud (COM 1)
- 38.400 Baud (COM 2)
- 230.400 Baud (COM 3)

**INFO**

The device would automatically select the communication rate appropriate for the related IO-Link device.

**INFO**

Maximum cable length for IO-Link communication is 20 m.

**INFO**

A large selection of connection cables can be found on the Baumer website <https://www.baumer.com>.

7.1.3 EtherCAT communication

Connection of M12 female connector

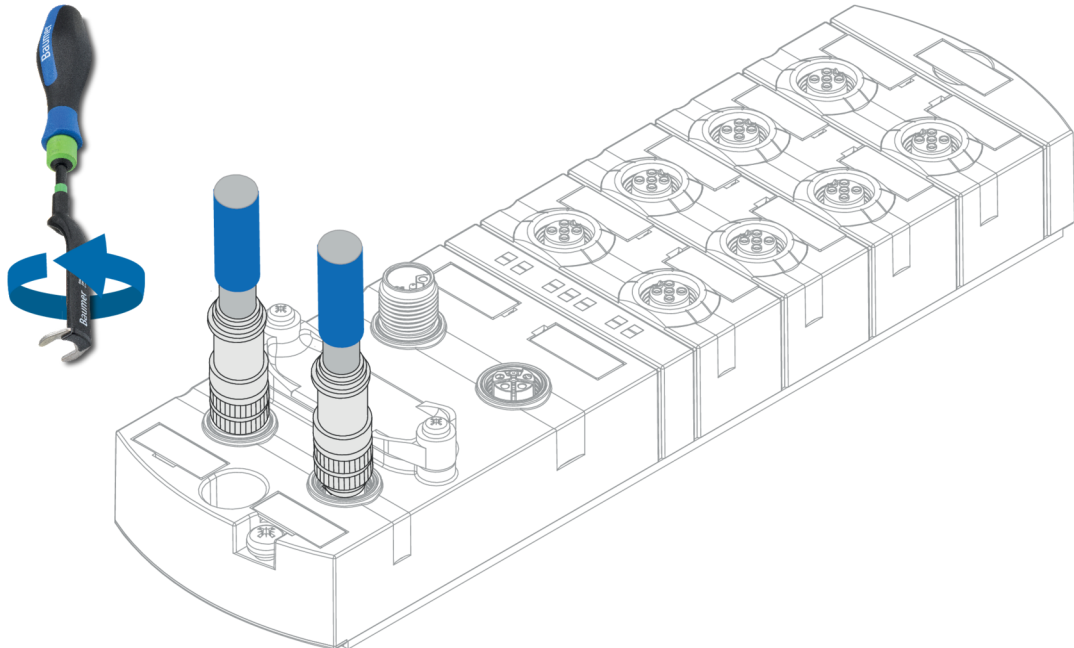
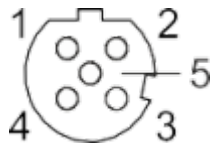

III. 11: Example of M12 connection (EtherNet/IP Bus)

M12	0.6 Nm		Art.-No. 7000-99102-000000
-----	--------	--	-------------------------------

Also see about this

[Pin assignment \[▶ 9\]](#)

7.1.4 Power supply

Connection with M12

POWER IN

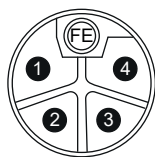

POWER OUT

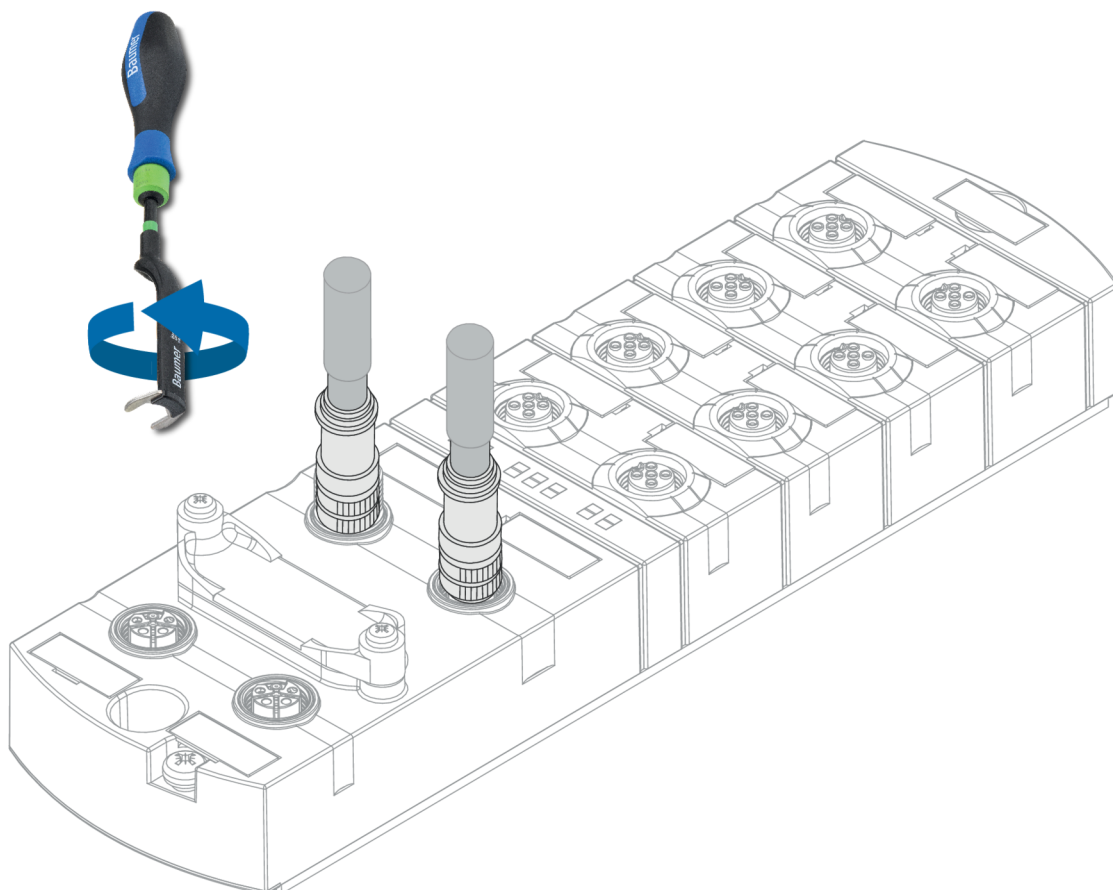
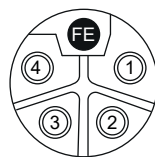

III. 12: Example of M12 connection (POWER)

M12	0.6 Nm		Art.-No. 7000-99102-000000
-----	--------	--	-------------------------------



INFO

A large selection of connection cables can be found on the Baumer website <https://www.baumer.com>.

7.2 Ensuring Tightness (IP67)

CAUTION

Leaky housing.

Risk of personal injury and material damage due to failure caused by ingress of conductive liquids.

- a) Seal any male and female connectors not in use.

Cable connection



III. 13:

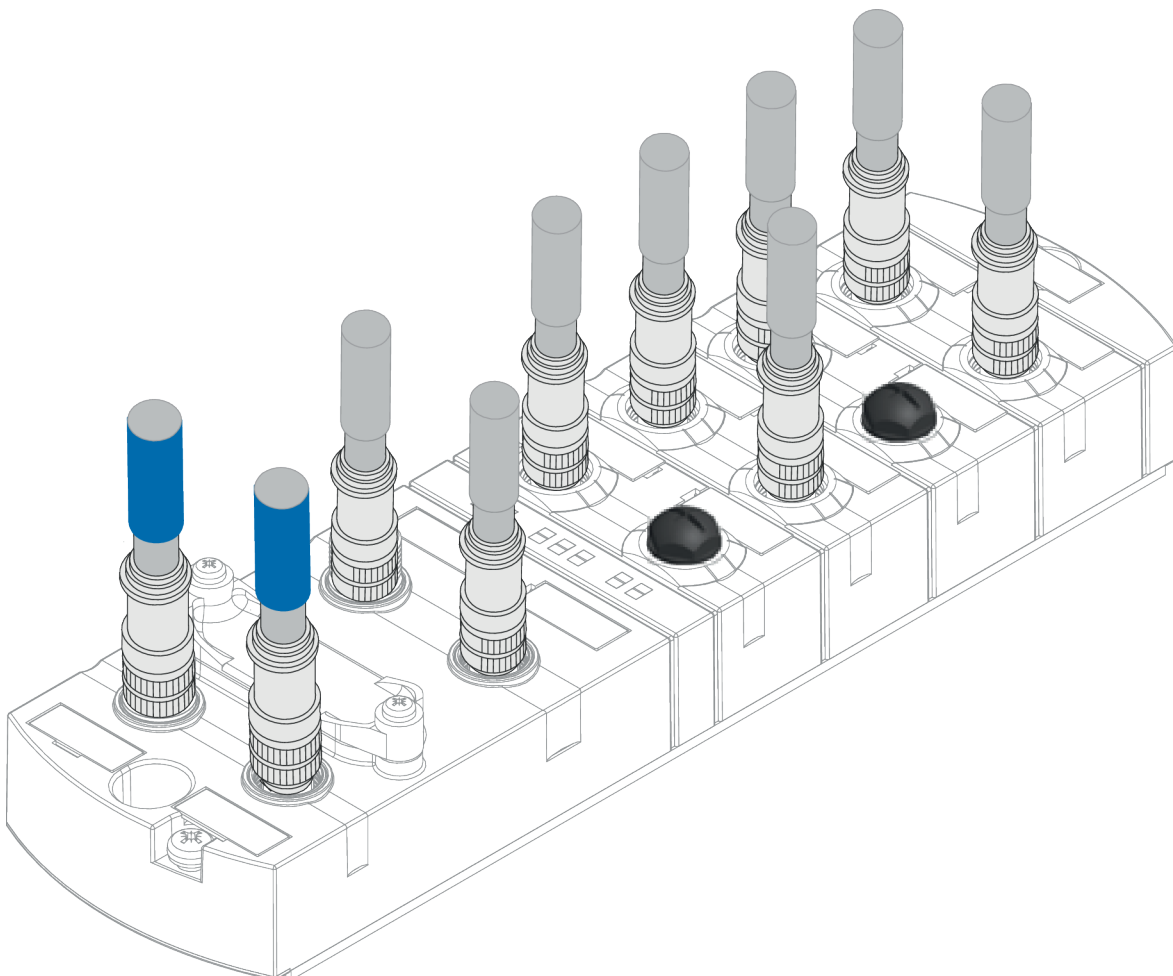

III. 14: Cable connection

M12	0,6 Nm		Art.-No. 7000-99102-0000000
-----	--------	--	--------------------------------

**INFO**

A large selection of connection cables can be found on the Baumer website <https://www.baumer.com>.

8 Commissioning

WARNING

Risk of burns.

Prohibited to separate or establish electrical connection during operation. Failure to observe this warning may result in electric arcs that can cause burns.

- a) Disconnect device from power supply.

CAUTION

Uncontrolled processes.

Personal injury and material damage due to incorrect commissioning (initial commissioning, device restart or change in device configuration).

- a) Commissioning should always observe the order below:

- a) Insert the device.
- b) System check and approval by an expert.
- c) Put into operation.

CAUTION

Functional errors in residential areas.

Devices of EMC Class A may cause interference in residential areas.

- a) The system operator must take appropriate measures.

8.1 EtherCAT

EtherCAT networks comprise at least the following components:

- 1 EtherCAT-master
- 1 or more slaves
- Ethernet cables and connectors for user connection

8.1.1 Integrating the device into Beckhoff TwinCAT V3

Twin-CAT® System Manager provides an example for both configuration and system integration to a Beckhoff TwinCAT control unit. Detailed proceedings depend on the applied project planning software.

When using other control units and project planning software, please see the related documentation.

ESI file installation

Instruction:

- a) Download ESI files at www.baumer.com.
- b) Copy ESI file to the TwinCAT directory.
Standard path: C:\TwinCAT\3.1\Config\Io\EtherCAT

Result:

- ✓ The installed devices are accessible at next TwinCAT System Manager boot up.

8.1.2 Device implementation

Device implementation is either manually or by automated scan.



INFO

Prior to connecting devices to the EtherCAT network, the EtherCAT system must be in a safe zero-current status.

Automated device scan

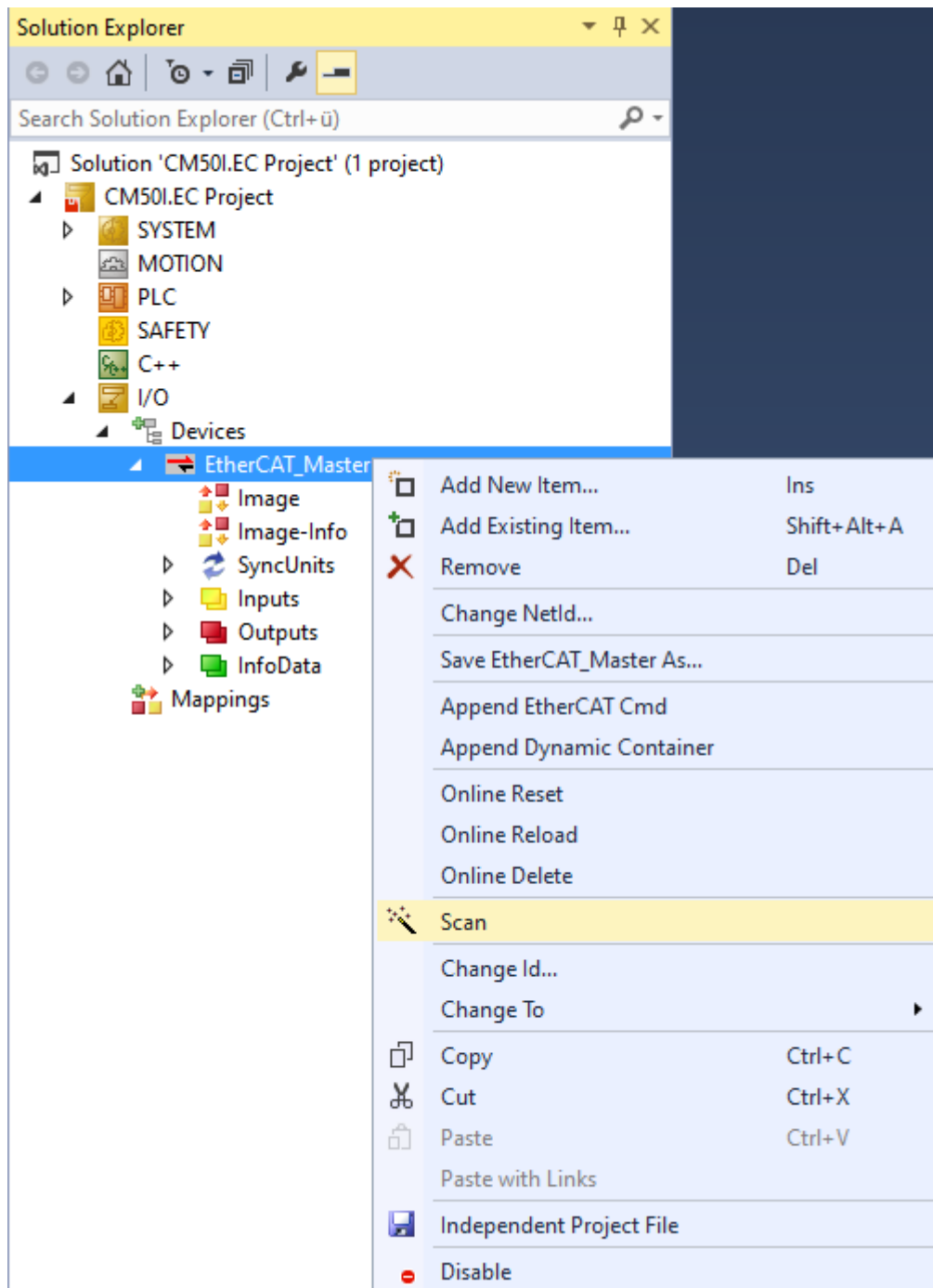

III. 15: Automated device scan

- a) Power on and start the TwinCAT System Manager in *Config mode*.
- b) Switch on supply voltage.
- c) Scan the device.

Adding device manually

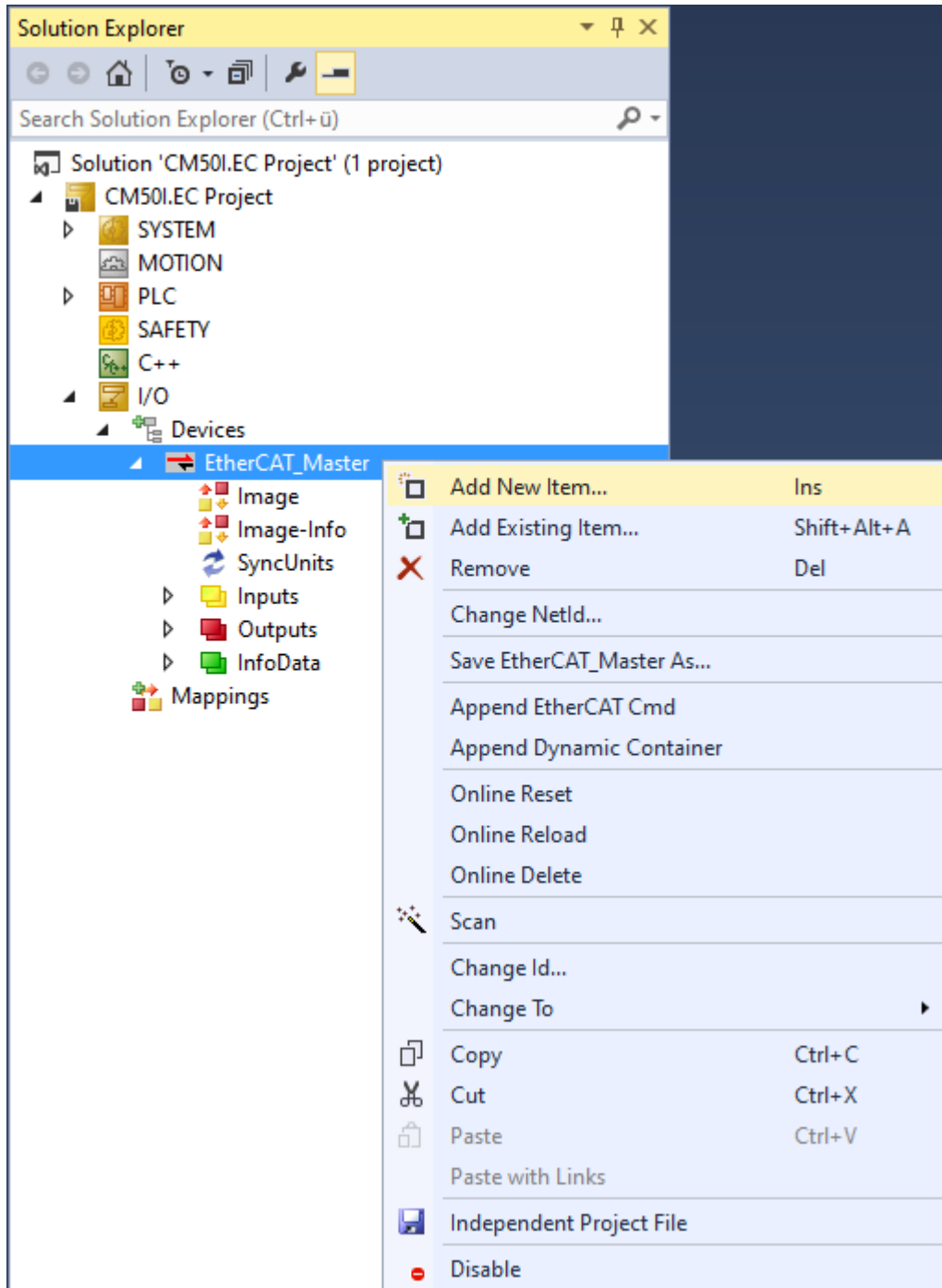

III. 16: Adding device manually

- a) Power on and start the TwinCAT System Manager in *Config mode*.
- b) Switch on supply voltage.

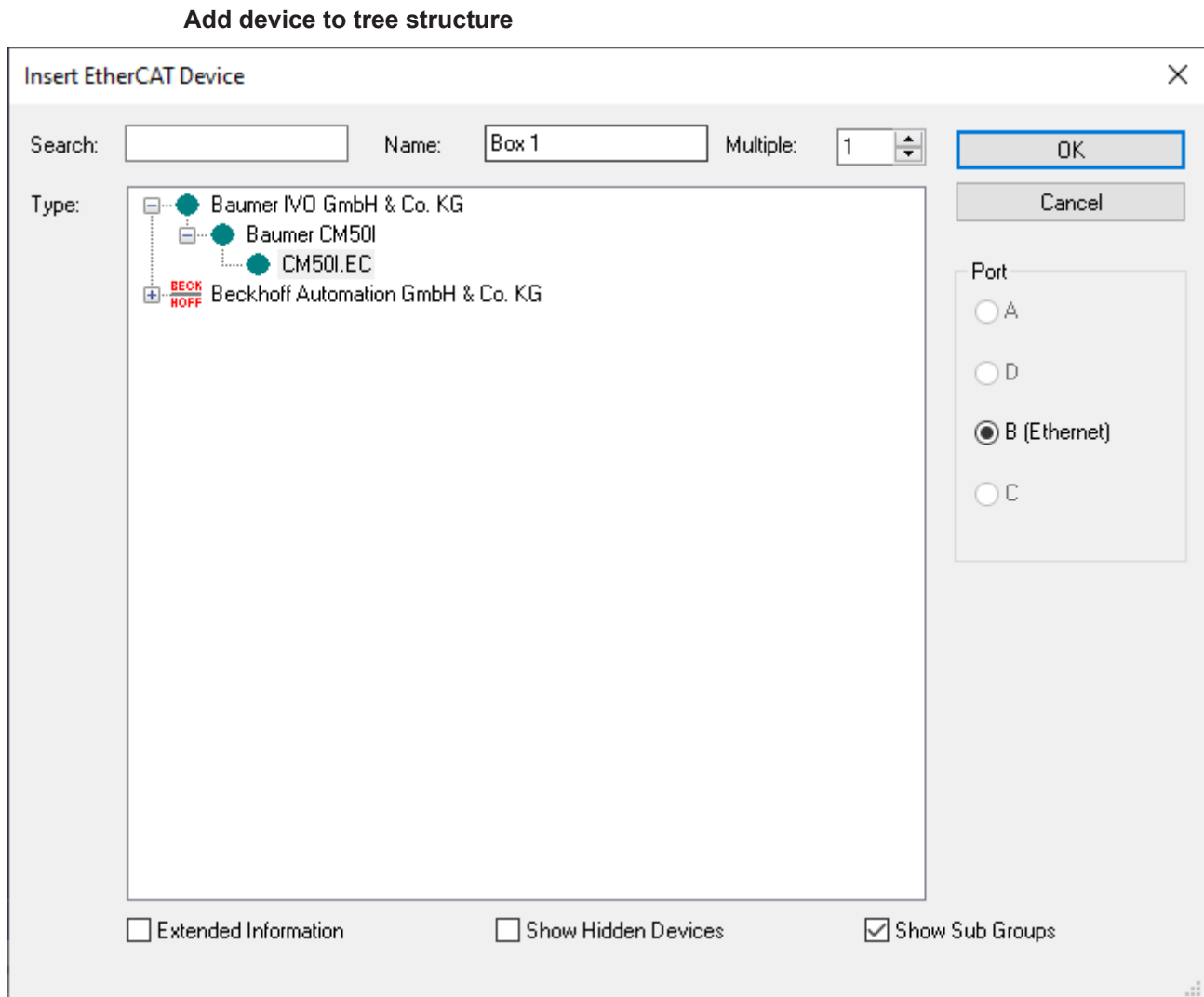

III. 17: Add device to tree structure

- a) Select device.
- b) Click **OK**.

Required device settings

Once being scanned or added manually the device appears in the TwinCAT tree.

Name	Online	Type	Size	> Addr...
PD (I/Q Pin2 + C/Q Pin4)		UINT	2.0	39.0
New Message Available Flag		BIT	0.1	41.0
State of IO-Link Port X0		USINT	1.0	42.0
State of IO-Link Port X1		USINT	1.0	43.0
State of IO-Link Port X2		USINT	1.0	44.0

III. 18: Device settings

8.1.3 Explicit Device ID

Explicit Device ID is used for EtherCAT function *HotConnect*.

There are two options for setting the *identification value*:

- using rotary switch
- writing on EEPROMs

Identification value settings using the rotary switch

Set identification value on tab ***EtherCAT***.

This value is compared to the value set by the rotary switches.

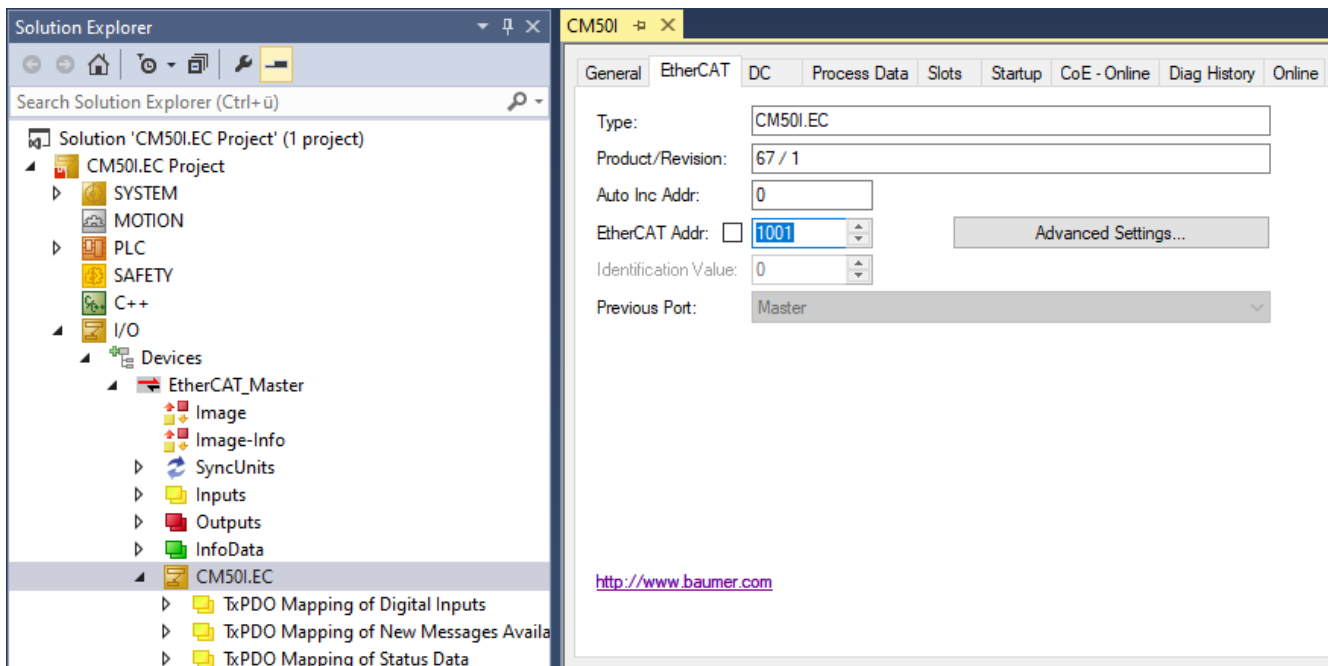
**Instruction:**

- EtherCAT-Select device *CM50I.EC*.
- On tab **EtherCAT** select **Advanced Settings....**

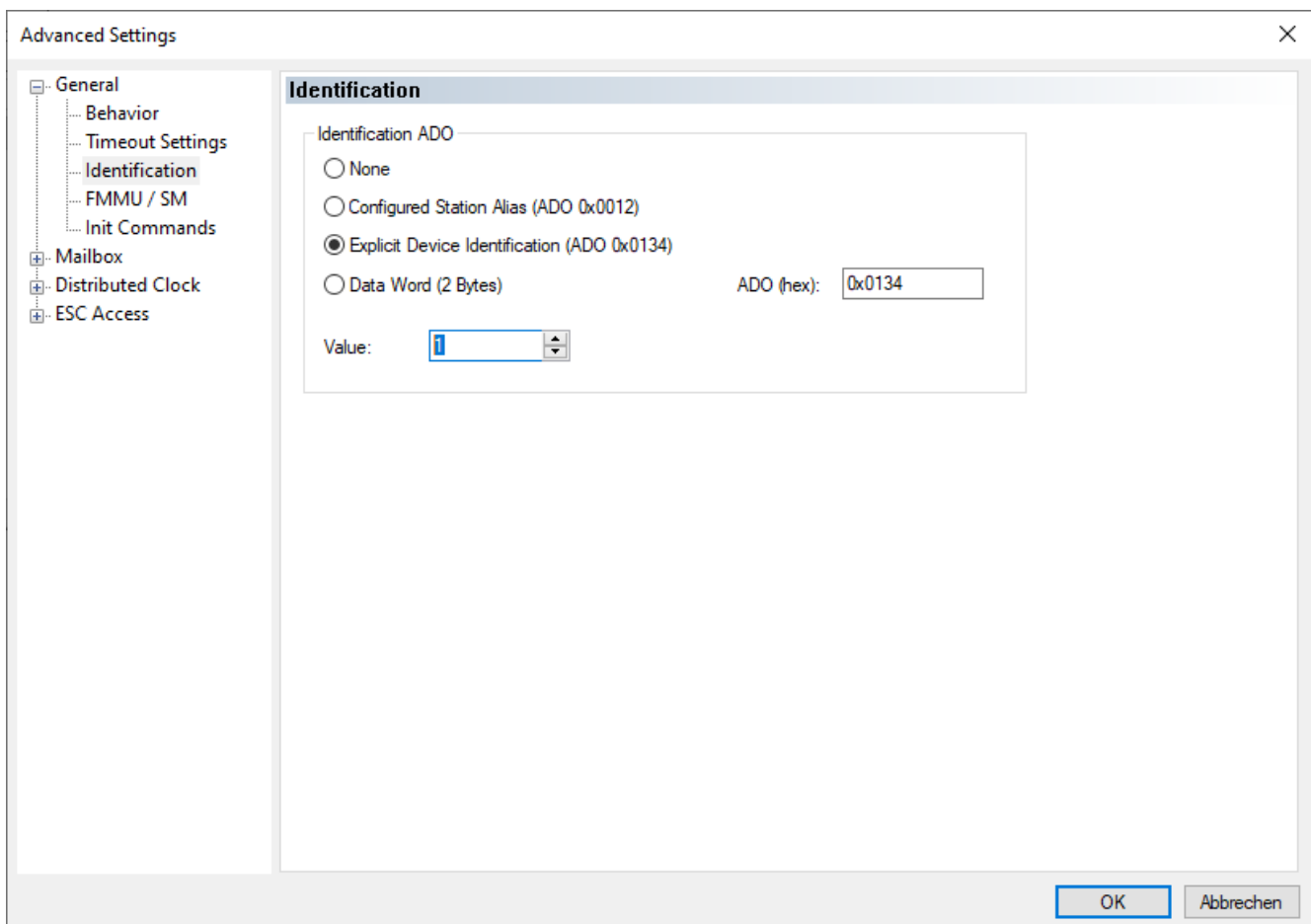

- Select **Identification** > **Explicit Device Identification**.
- Define address at **Value**.

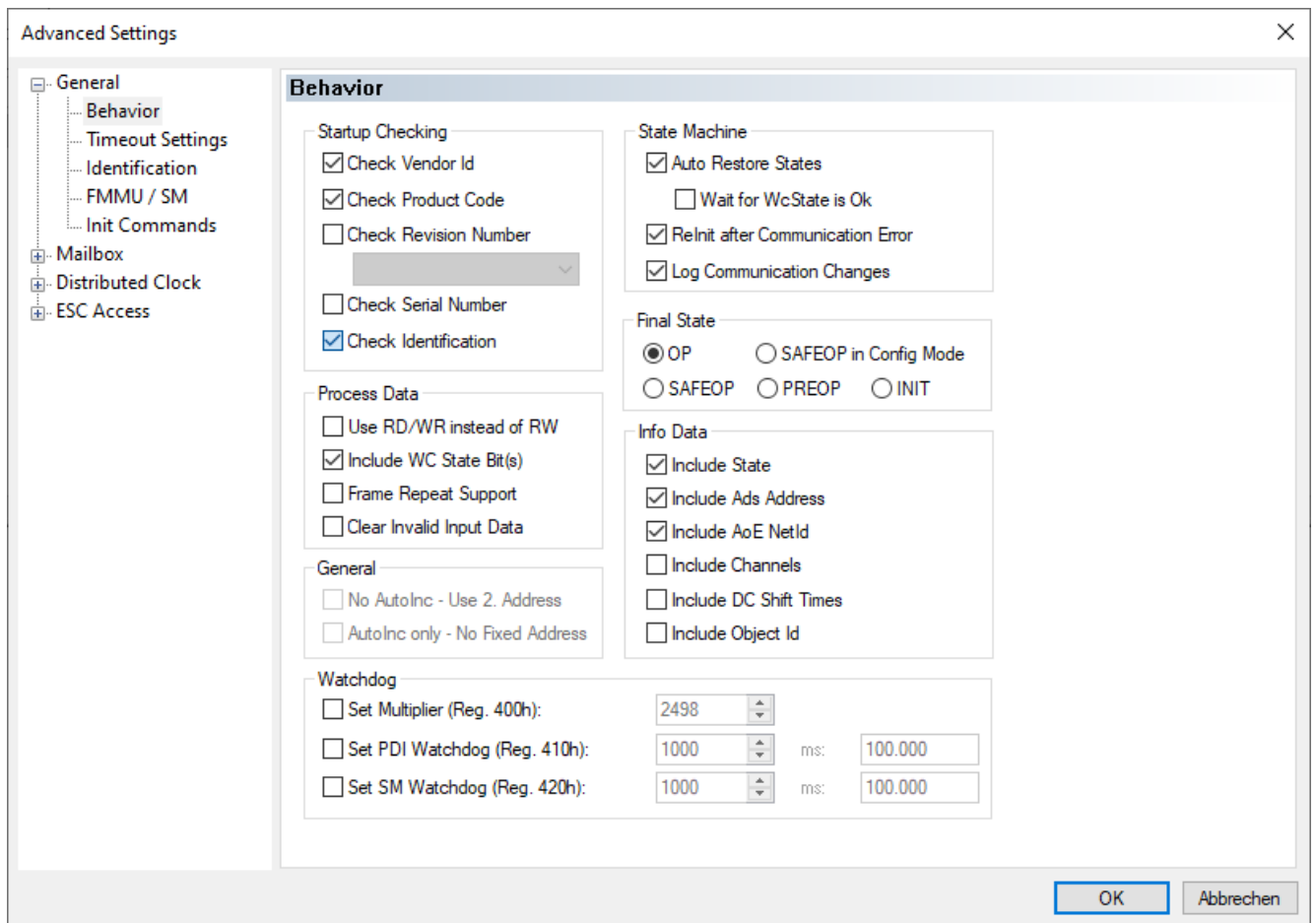

- Under **General > Behavior** tick checkbox **Check Identification**.
- Click **OK**.
- Switch off the device and set the same identification value using the rotary switches.
- Switch device power on again.
- Compile project and download to PLC.

Identification value setting via EEPROM

Set identification value on tab **EtherCAT**.

This value is compared to the value set in EEPROM.

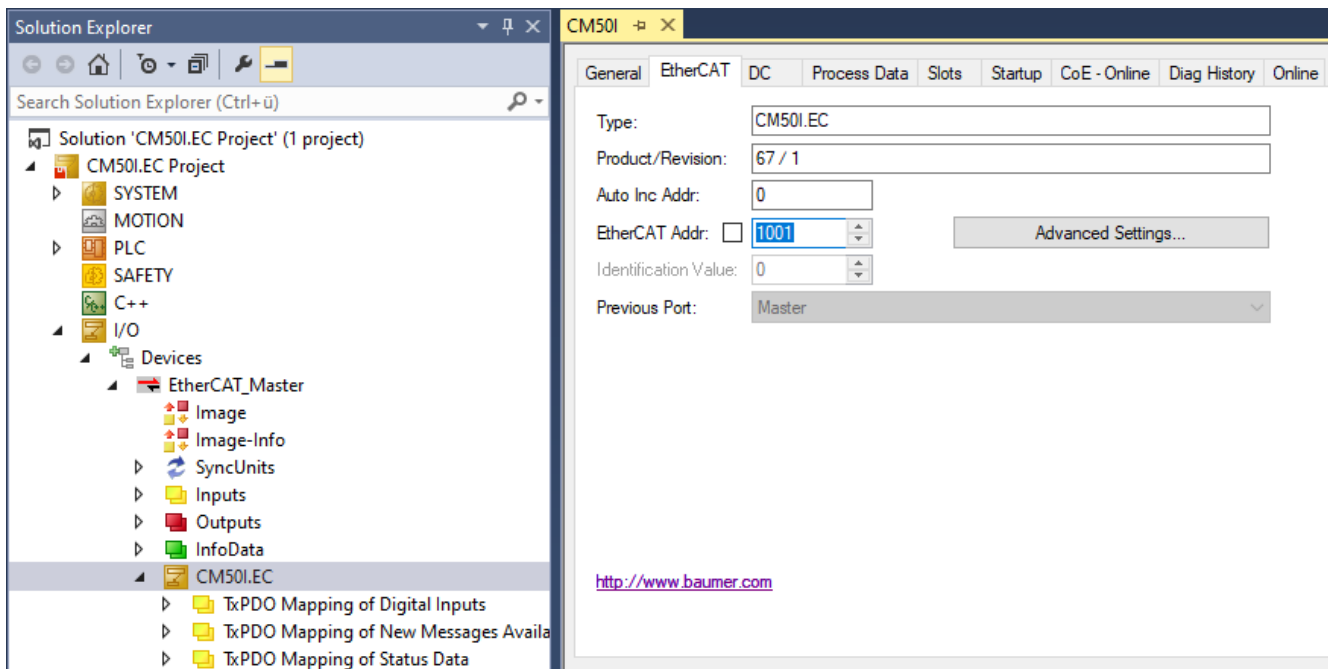

- a) EtherCAT-Select device *CM50I.EC*.
- b) On tab ***EtherCAT*** select ***Advanced Settings....***

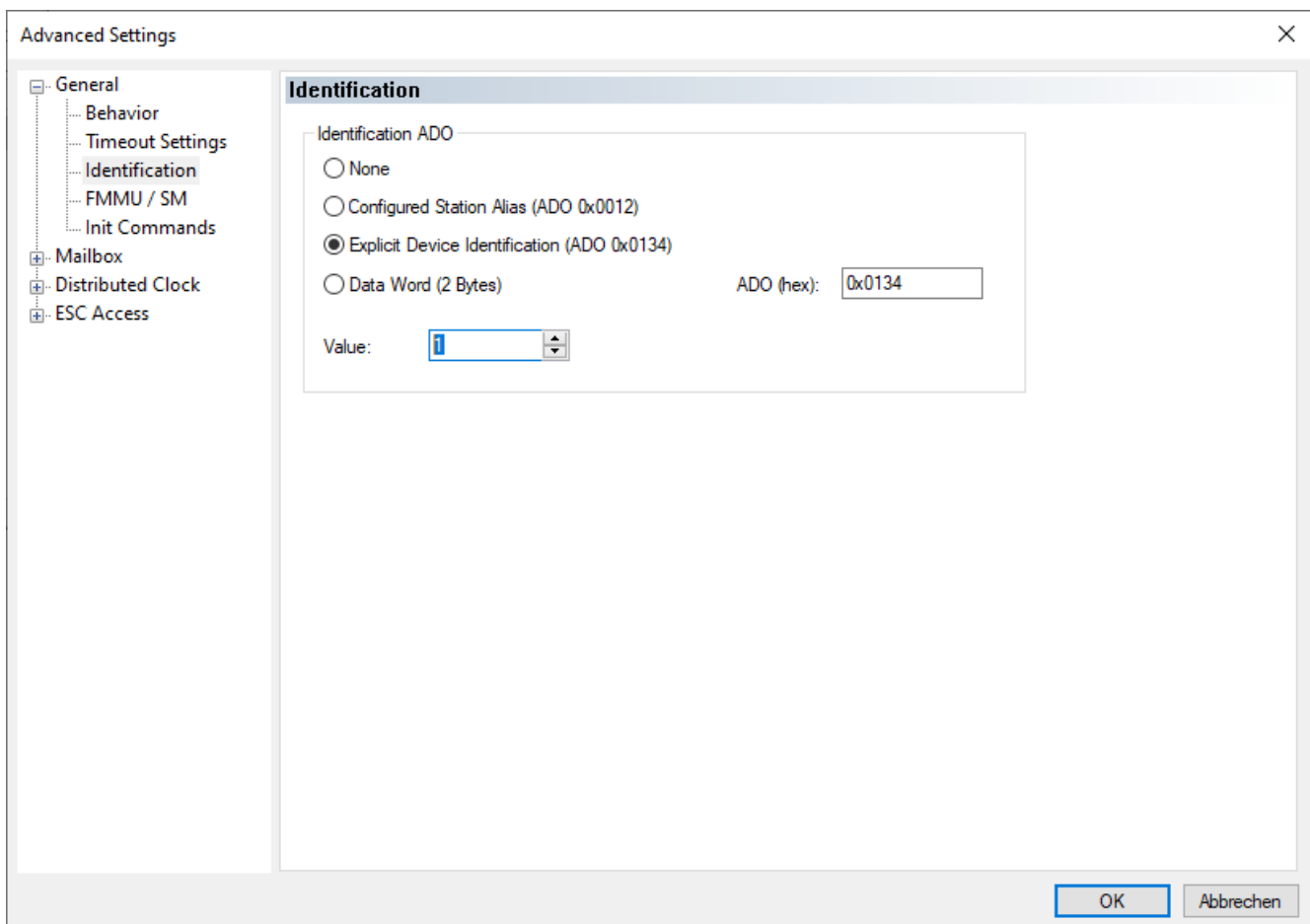

- a) Select ***Identification*** > ***Explicit Device Identification***.
- b) Define address at ***Value***.

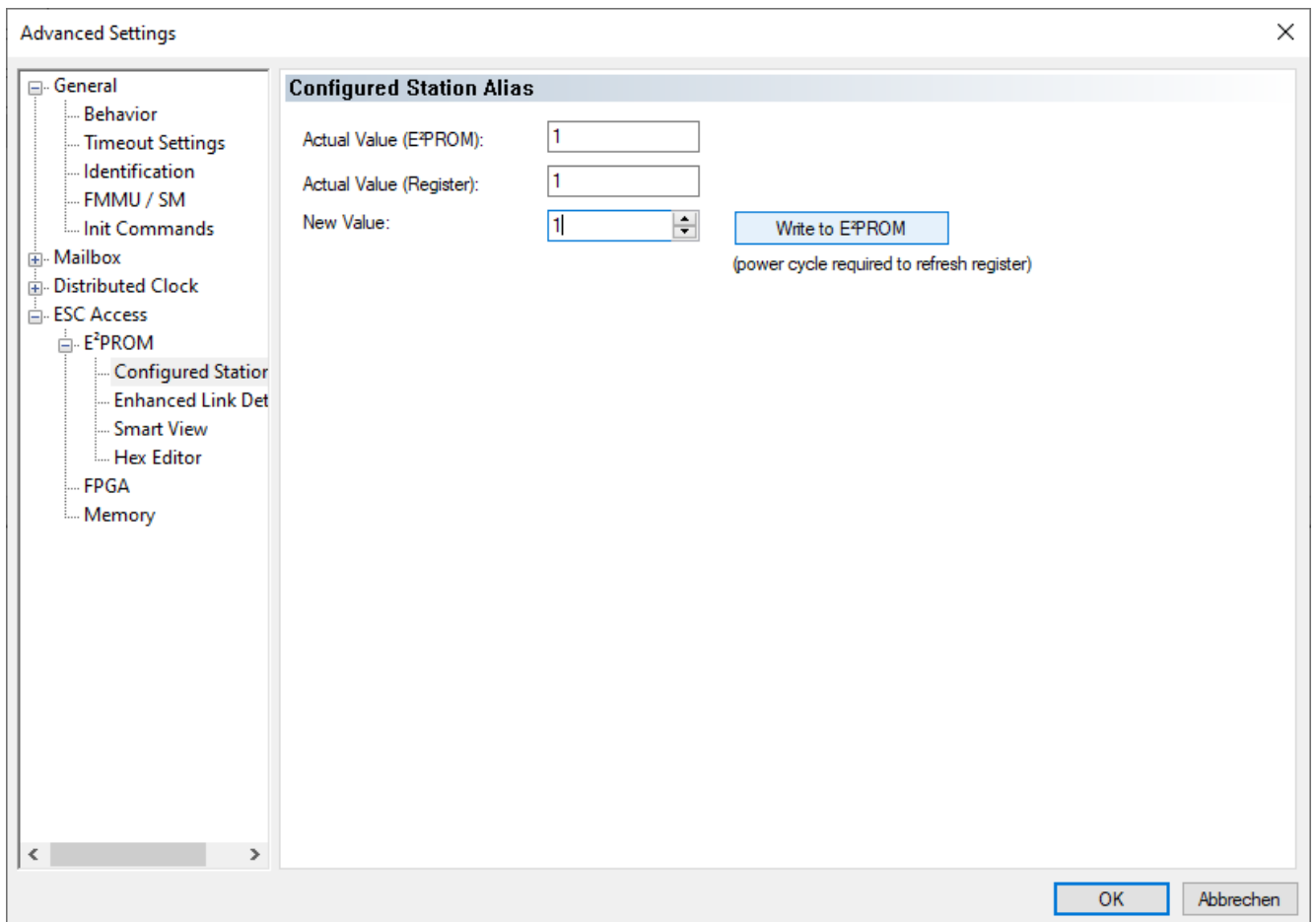

- Select **Configured Station Alias**.
- At **New Value**, set the same identification value that was previously defined.
- Click on **Write to E²PROM**.

Result:

- ✓ The address value in EEPROM has been saved.

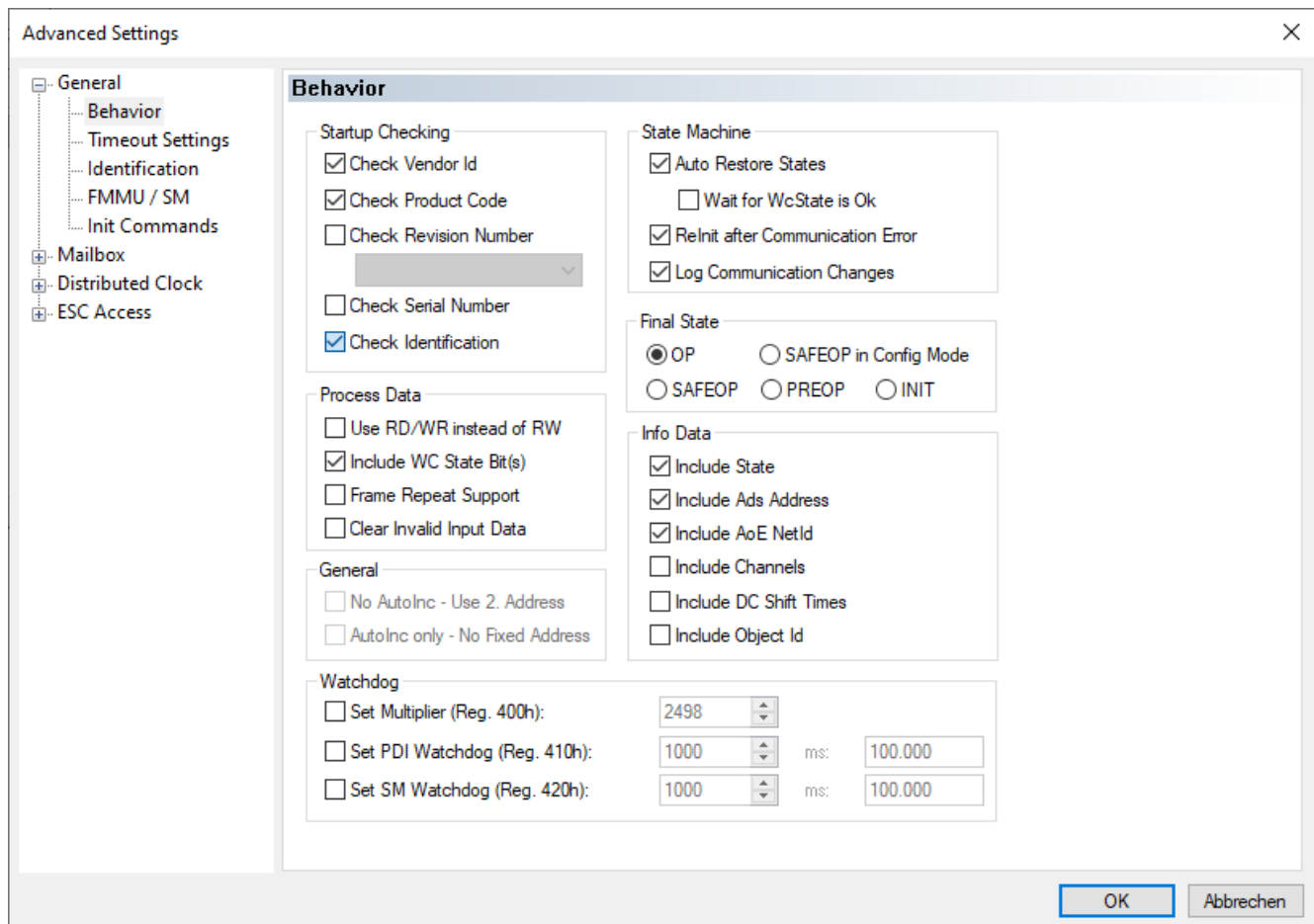

- a) Under **General > Behavior** tick checkbox **Check Identification**.
- b) Click **OK**.
- c) Switch device power on again.
- d) Compile project and download to PLC.

8.1.4 AoE

The master device supports reading and writing of IO-Link parameters via AoE (ADS over EtherCAT).

Acyclic communication to the IO-Link device is executed via command ADS. The ADS address required comprises the NetID and the IO-Link master port number.

AoE NetID

The master device is given a AoE NetID of its own IO-Link master communication.

NetID is assigned by the configuration tool at:

- **CM50I.EC > Tab EtherCAT > Advanced Settings > Mailbox > AoE > NetId.**

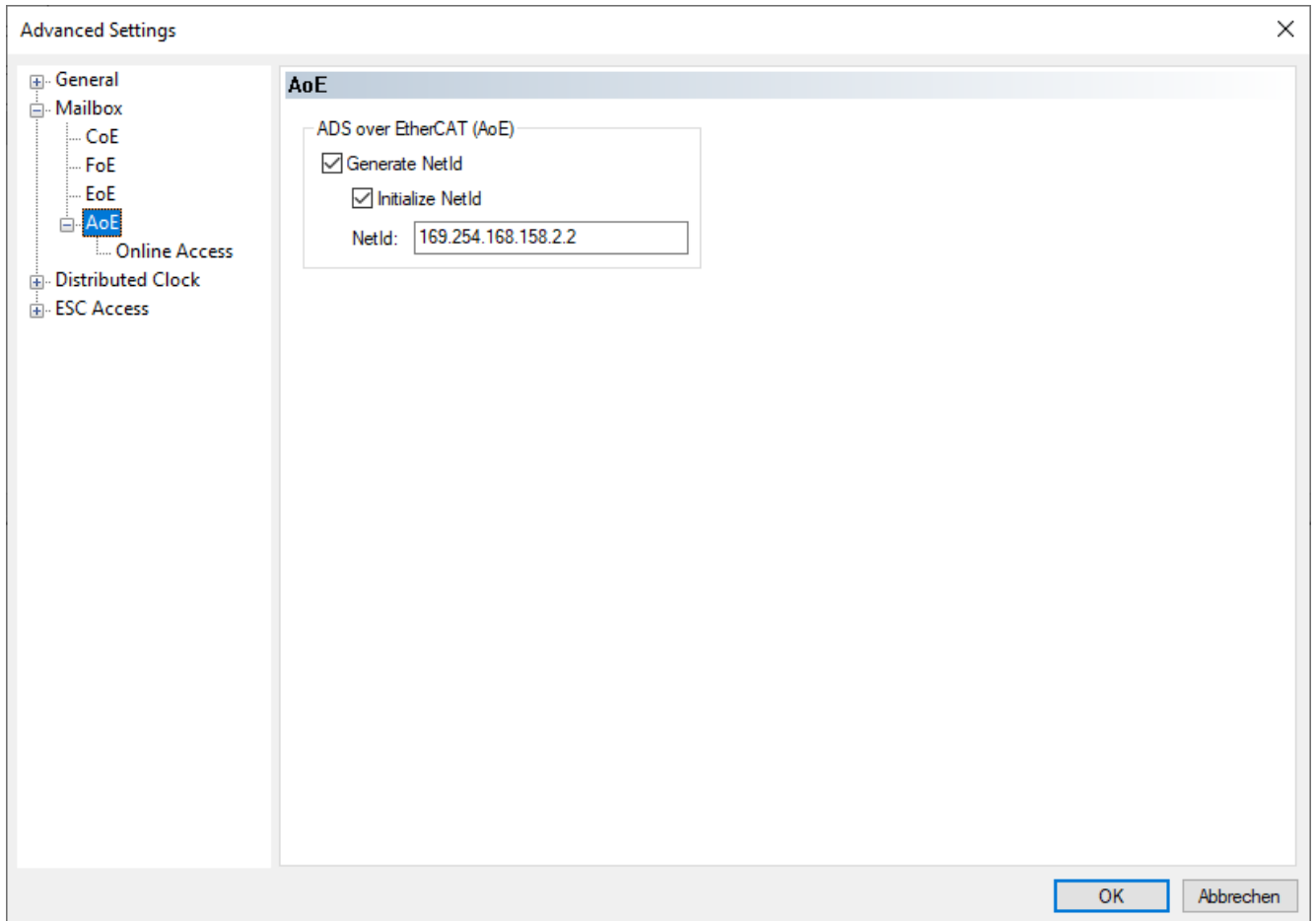

III. 19: AoE NetID

IO-Link master Port number

The individual IO-Link ports of the master device are assigned via the port number. Port numbers are assigned in ascending order from $0x1000$ (4096dec).

The following applies to the IO-Link master:

Port	Port number	Hex	Dec
X0	1	0x1000	4096
X1	2	0x1001	4097
X2	3	0x1002	4098
X3	4	0x1003	4099
X4	5	0x1004	5000
X5	6	0x1005	5001
X6	7	0x1006	5002
X7	8	0x1007	5003

ADS Index Group

In IO-Link EtherCat integration xyz, the index group for the ADS command was set to $0xF302$, as with CoE.

ADS Index Offset

Addressing index and subindex of the IO-Link request is saved in the index offset comprising 4 bytes. Split as follows:

- 2 Byte Index
- 1 Byte Reserverd
- 1 Byte Subindex

Example: When reading subindex 0x20 (32dec) from index 0x40 (64dec), index offset 0x00 40 00 20 is required.

8.1.5 EoE

Device supports EoE (Ethernet over Ethercat). To configure TwinCAT accordingly, go to tab **EtherCAT** and select **Advanced Settings**.

- **CM50I.EC** > Tab **EtherCAT** > **Advanced Settings** > **Mailbox** > **EoE** > **NetId**.

First, enter a valid DNS name and next a valid IP address.

The screenshot shows the 'Advanced Settings' dialog box with the 'EoE' tab selected. The left sidebar shows a tree view with 'General', 'Mailbox', 'CoE', 'FoE', 'EoE', 'AoE', 'Distributed Clock', and 'ESC Access'. The 'EoE' section is expanded, showing the following configuration:

- Virtual Ethernet Port
 - Virtual MAC Id: 02 01 05 10 03 e9
- Switch Port
- IP Port
 - DHCP
 - IP Address
 - IP Address: 192.168.0.250
 - Subnet Mask: 255.255.255.0
 - Default Gateway: 192.168.0.100
 - DNS Server: . . .
 - DNS Name: Box_1_Baumer_1
- Time Stamp Requested

Buttons: OK, Abbrechen

III. 20: Function EoE



INFO

Function *EoE* is enabled by default. Function is disabled by selecting **Virtual Ethernet Port**.

8.1.6 Firmware update via FoE

Requirements

- TwinCAT V2 or V3
- Existing TwinCAT configuration including EtherCAT slave update.

Firmware update (with TwinCAT V3)

Instruction:

- a) Open the "Online" page of the EtherCAT slave at TwinCAT and set it to status Pre-Op.
- b) Click on **Download**.

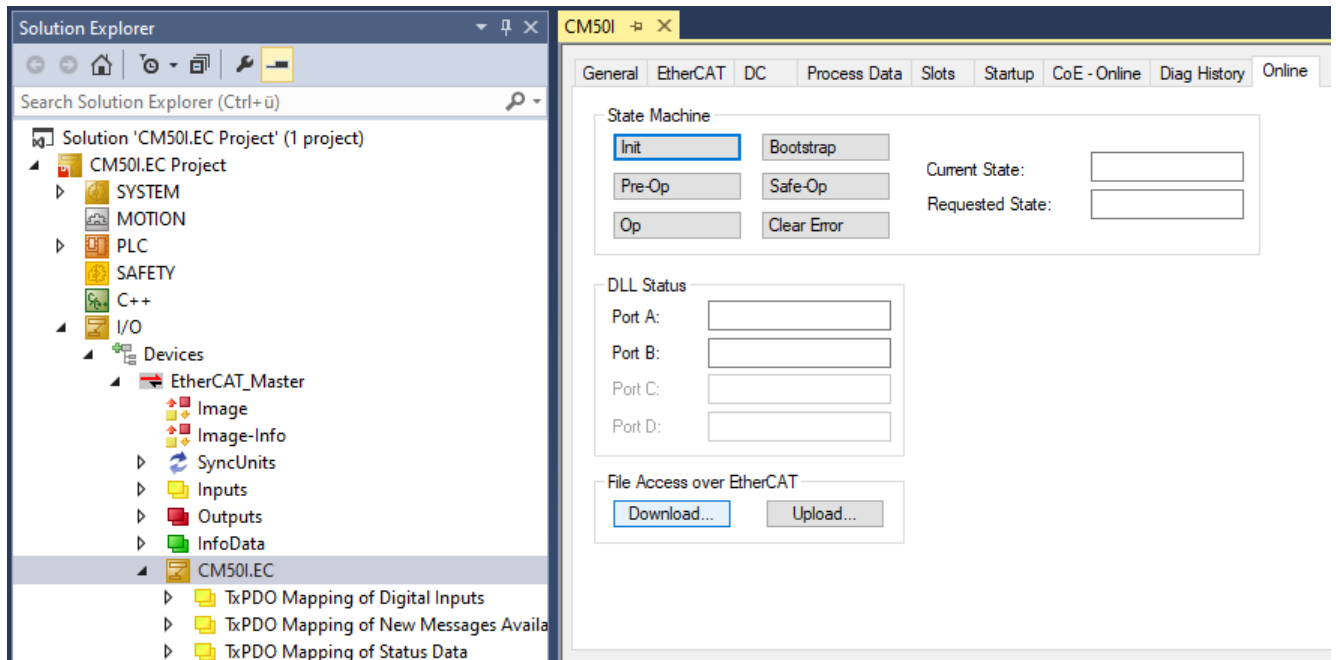

///. 21: Firmware update download

Download firmware update

- a) Select file type All Files (*.*)
- b) Download file ..._fwupdate.zip.
- c) Click **open**.

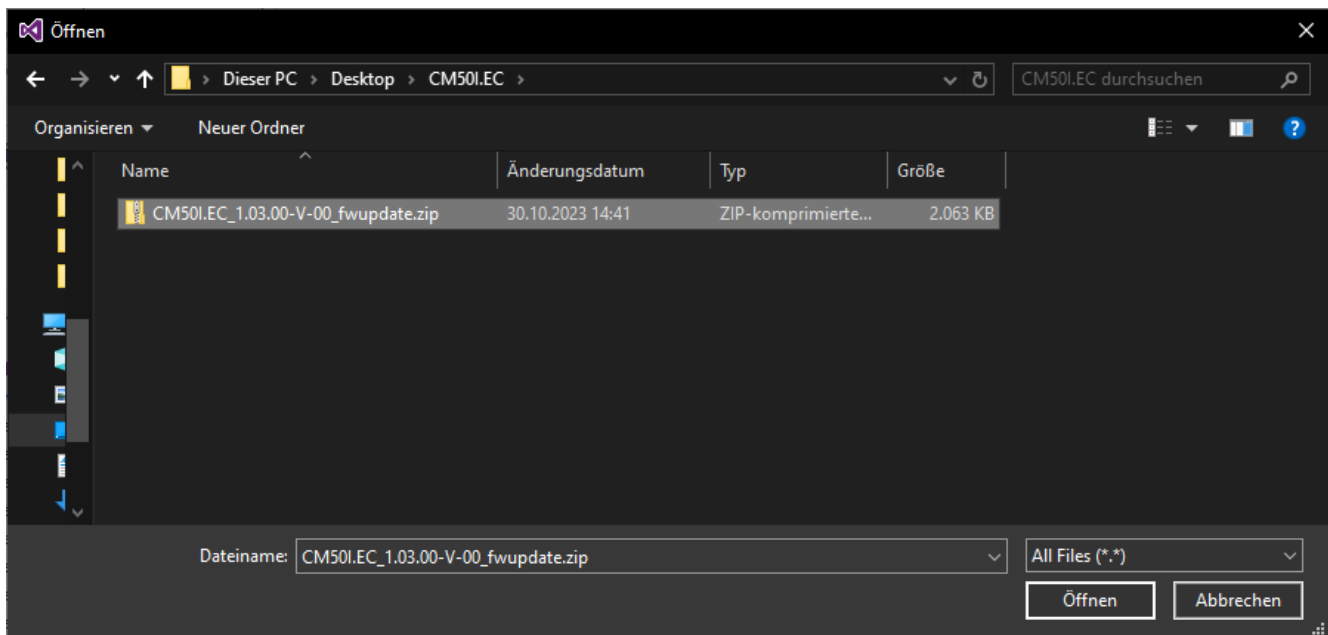

III. 22: Open firmware update

Enter FoE name

- a) In button **String** enter the name of the update file previously downloaded.
- b) Click **OK**.

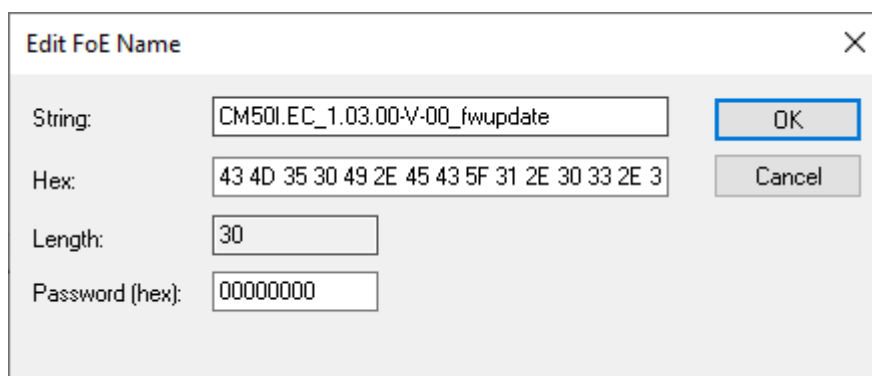

III. 23: Enter FoE name



INFO

Please wait until download is complete (approx. 1 minute). In TwinCAT there is no screen refresh while the download is running.

Open firmware update

- a) Click on tab **CoE – Online**.
- b) Scroll down to object **5FFE:0 Update Firmware** and open sub-object **5FFE:01 Reset and Update FW immediately**.
- c) Double-click on sub-object **5FFE:01 Reset and Update FW immediately**, reset and update firmware immediately.

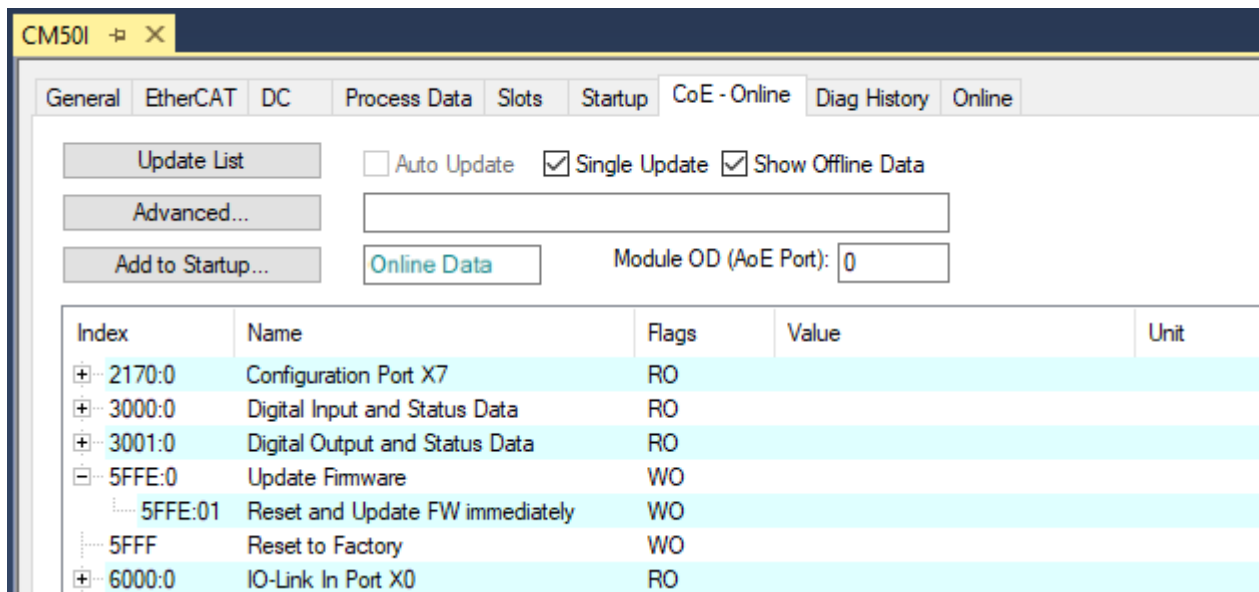

///. 24: Open firmware update

Enter value

- Any value within the range 1 ... 255.
- Click **OK**.

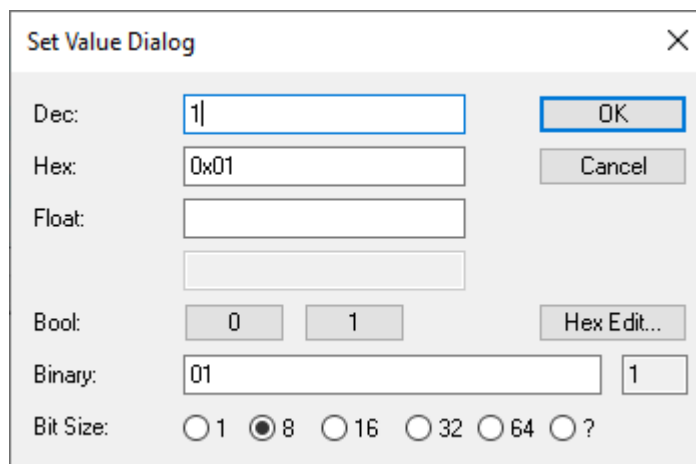

///. 25: Enter value

Start firmware update

Device starts firmware update. All LED status indicators at front are off.

After less than a minute, the device restarts with the new firmware, see CoE object **100A Software version of the manufacturer**.

9 Configuration/setting

Overview

There are two options for device configuration.

- First: GSDML file is available for download at the Baumer Website.
 - As described in chapter *Read GSDML files* they can be imported into the programming software to benefit from pre-configured connections.
- Second: Device configuration via the integrated web server.



INFO

To adopt index changes made via Webserver and via acyclic ISDU into DataStorage, a *ParamDownloadStore Command* must be transmitted after the index change.

- a) The *ParamDownloadStore Command* can be triggered by writing value 0x05 to index 0x02.

9.1 IO-Link master configuration

IO-Link master structure

The IO-Link master is a modular device with 8 slots.



INFO

Each slot corresponds to a female 4-pin M12.

The slot can be assigned a defined number of process data (buffer size). The connected device specifies the process data length at a port.

- Select the correct module depending on the connected device.

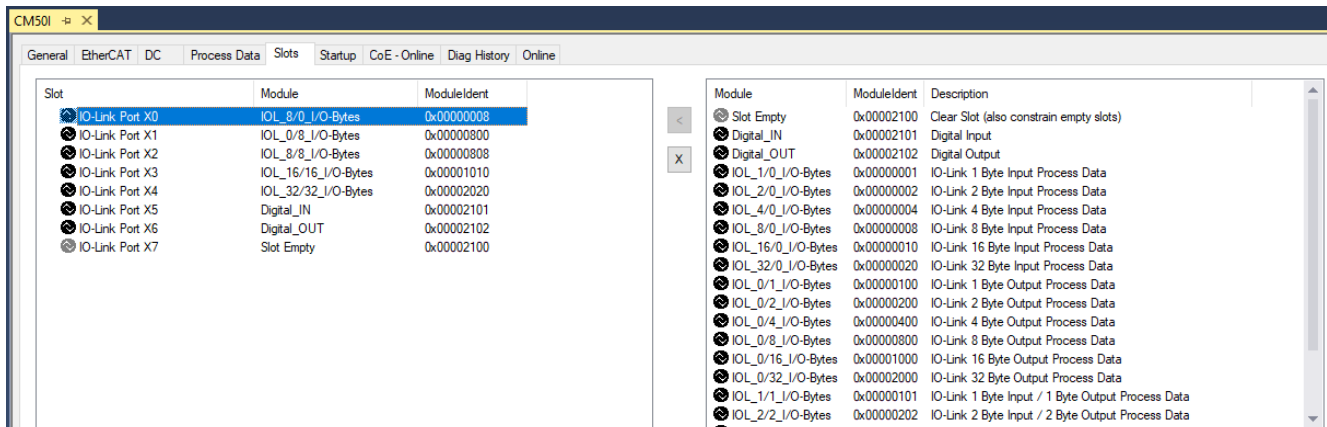

III. 26: IO-Link master structure

Slot devices

Slot devices structure is according to the following diagram:

	Description
IOL_x/y_I/O-Bytes	Number of process data used for IO-Link device. The number should be equal to or greater than the process data length of the IO-Link device. <ul style="list-style-type: none"> ■ x: Input data

	Description
	<ul style="list-style-type: none"> ▪ y: Output data
Digital IN	Input Pin 4
Digital OUT	Output Pin 4
Slot disabled	If Pin 4 on Slot is not used.

Module overview

Slot empty
Digital_IN
Digital_OUT
IOL_1/0_I/O-Byte
IOL_2/0_I/O-Byte
IOL_4/0_I/O-Byte
IOL_8/0_I/O-Byte
IOL_16/0_I/O-Byte
IOL_32/0_I/O-Byte
IOL_0/1_I/O-Byte
IOL_0/2_I/O-Byte
IOL_0/4_I/O-Byte
IOL_0/8_I/O-Byte
IOL_0/16_I/O-Byte
IOL_0/32_I/O-Byte
IOL_1/1_I/O-Byte
IOL_2/2_I/O-Byte
IOL_4/4_I/O-Byte
IOL_8/8_I/O-Byte
IOL_16/16_I/OByte
IOL_32/32_I/OByte

9.2 IO-Link master parameterization

Module parameters and individual ports can be set via tab **Startup**.

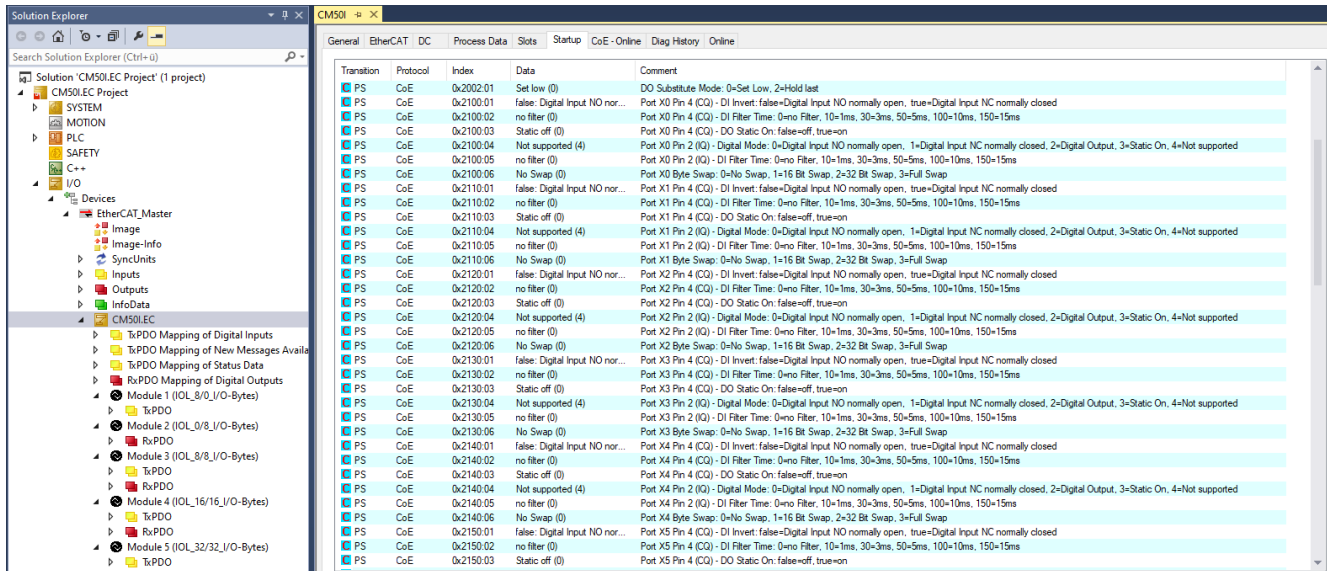

III. 27: Select object

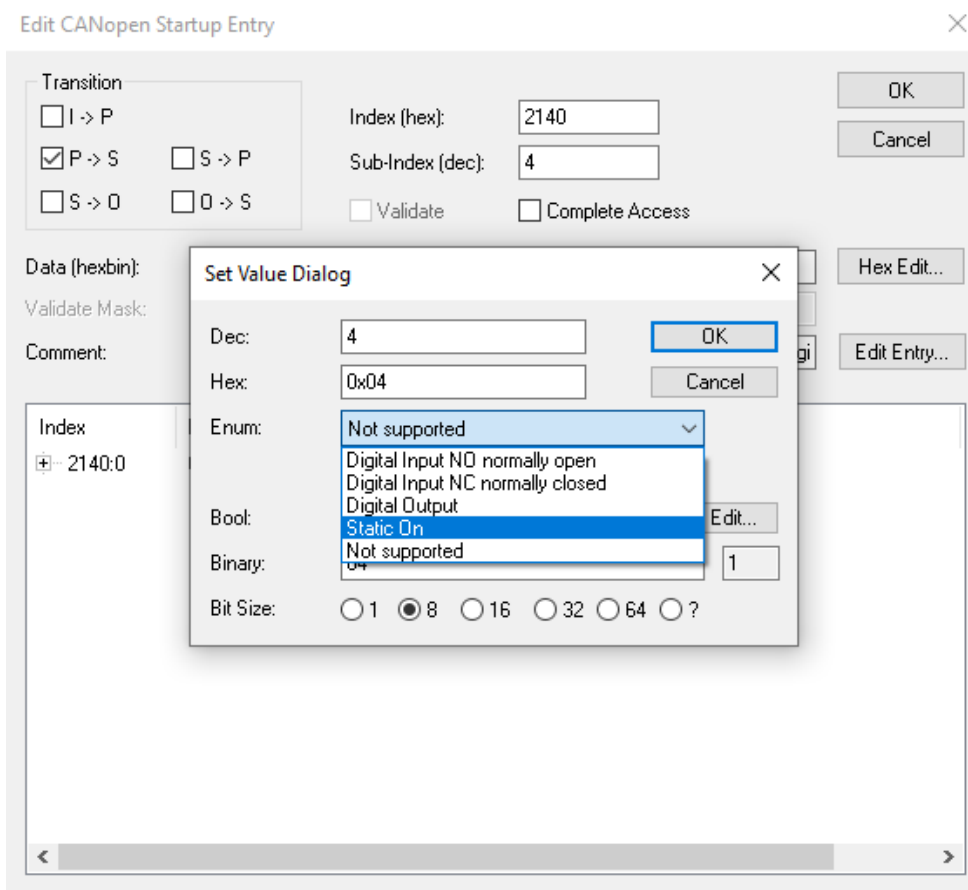

III. 28: Value setting

Instruction:

- a) Select object
- b) If *ENUM* is supported you can call up a context menu for value setting.

Result:

- ✓ The settings are transmitted together with the configuration.

Module parameters

Pin/port-based IO layout defines the channel layout in the process data. This applies to both inputs and outputs.

Selection	Index	Subindex	Significance
0	0x2001	00	Port-based: Layout is sorted in ascending port order. [Default]
1			Pin-based: Layout is sorted in ascending pin order.

DO Substitute Mode

If fieldbus communication is interrupted, the predefined output status is present.

Selection	Index	Subindex	Significance
0	0x2002	01	Off [default value]
1			Power on
2			Last status

Port parameters Pin4 (C/Q) SIO mode and Pin2 (I/Q)

Digital I/O parameterization at ports X0... X7:

Selection	Index	Subindex	Significance
0	0x21n0	01	Port-based: Layout is sorted in ascending port order. [Default]
1			Pin-based: Layout is sorted in ascending pin order.

Tab. 2: Port X_ Pin4 (C/Q) SIO DI Invert

Selection	Index	Subindex	Significance
0	0x21n0	02	Without filter [default value]
10			1 ms
30			3 ms
50			5 ms
150			15 ms

Tab. 3: Port X_ Pin4 (C/Q) SIO DI Filter Time

Selection	Index	Subindex	Significance
0	0x21n0	04	Digital input NO (normally open)
1			Digital input NC (normally closed)
2			Digital output
3			Static digital output
4			Not supported [default value]

Tab. 4: Port X_ Pin2 (I/Q) Function

Selection	Index	Subindex	Significance
0	0x21n0	05	Without filter [default value]
10			1 ms
30			3 ms

Selection	Index	Subindex	Significance
50			5 ms
150			15 ms

Tab. 5: Port X_ Pin2 (I/Q) DI Filter Time

IO-Link master parameters

Selection	Description
Device ID	IO-Link Device ID
Vendor ID	Manufacturer ID of the IO-Link device
IO-Link revision	Version of implemented IO-Link specification (of the connected IO-Link device). <ul style="list-style-type: none"> ▪ 0: Plausibility check disabled ▪ 11: Plausibility check enabled
Cycletime	Cycle time applied by master to this port. Any value other than zero will set IO-Link to manual mode: <ul style="list-style-type: none"> ▪ 0: as soon as possible ▪ 32: 3.2 ms ▪ 40: 4.0 ms ▪ 48: 4.8 ms ▪ 68: 6.8 ms ▪ 73: 10 ms ▪ 88: 16 ms ▪ 100: 20.8 ms ▪ 128: 32 ms ▪ 133: 40 ms ▪ 148: 64 ms ▪ 158: 80 ms ▪ 183: 120 ms ▪ 188: 128 ms
Process data IN lenght	Number and structure of input data
Process data OUT lenght	Number and structure of outgoing data
Master control	IO-Link DataStorage functionality * <ul style="list-style-type: none"> ▪ 0x003 = No data memory [default value] ▪ 0x023 = Backup + Restore ▪ 0x043 = Restore

Tab. 6: Configuration Data Port X_

* When switching to the *Restore* status, any device configurations previously saved in the device are discarded, especially when switching from *Backup&Restore* to *Restore*.

Upon initial connection in status *Restore* of a compatible device:

- Master is retrieving the DataStorage data (one-time backup) from the device,
- saves them *and*

- transmits them to each newly connected compatible device, compatible with different configuration (*Restore*).

9.3 General EtherCAT objects

Explanation of the elements:

Access

Read and/or write accesses:

- RO: read-only access
- RW: Read and write access

Default

Preset value

UINT

Data type Unsigned INT

Device Type

Index	Name	Type	Access	Default value	Significance
0x1000	Device Type	UINT32	RO	0x00000000	Device type of the EtherCAT slave: <ul style="list-style-type: none"> The Lo-Word contains the CoE profile used (5001). The Hi-Word contains the module profile according to the modular device profile.

Error Register

Index	Name	Type	Access	Default value	Significance
0x1001	Error Register	UINT32	RO	0x00000000	Error Register Object Bit 0 = 1: Generic error Bit 1 = 1: Current error (SSC or ASC) Bit 2 = 1: Voltage error (LVS or LVA) Bit 3 ... 6: Reserved Bit 7 = 1: Internal device error (IME)

Manufacturer Device Name

Index	Name	Type	Access	Default value	Significance
0x1008	Name	VISIBLE STRING	RO	CM50I.EC	Device name of the EtherCAT slave

Manufacturer Hardware Version

Index	Name	Type	Access	Default value	Significance
0x1009	Hardware version	VISIBLE STRING	RO	Actual hardware version	Hardware version of the EtherCAT slave

Manufacturer Software Version

Index	Name	Type	Access	Default value	Significance
0x100A	Software version	VISIBLE STRING	RO	Actual firmware version	Firmware version of the EtherCAT slave

Identity Object

Index	Name	Type	Access	Default value	Significance
0x1018:00	Identify object	UINT8	RO	0x04 (4dec)	Information of the slave
0x1018:01	Vendor ID	UINT32	RO	0x4F (79dec)	Vendor ID of EtherCAT slave device manufacturer
0x1018:02	Product code			0xDC70 (56432dec)	Product code of the EtherCAT slave
0x1018:03	Revision			0x00000000 (0dec)	Revision number of the EtherCAT slave; the Low Word (bit 0-15) indicates the special terminal number, the High Word (bit 16-31) refers to the device description
0x1018:04	Serial number			0x00000000 (0dec)	Serial number of EtherCAT slave <ul style="list-style-type: none"> ■ the high word (bits 31-16) contains a consecutive number ■ the upper byte of the low word (bits 15-8) contains the manufacturing week ■ the lower byte of the low word (bits 7-0) contains the manufacturing year

Timestamp Object

Index	Name	Type	Access	Default value	Significance
0x10F8	Timestamp Object	UINT64	RO	–	Local timestamp of the device in [ns]

Diagnosis History

Index	Name	Type	Access	Default value	Significance
0x10F3	Diagnosis History	RECORD			
0x10F3:0	Diagnosis History	UINT8	RO	255	Highest supported subindex
0x10F3:1	Maximum Messages	UINT8	RO	0xFA (250dec)	Number of diagnosis messages which can be stored in the diagnosis history (subindex 6 onwards)
0x10F3:2	Newest Message	UINT8	RO	0	Subindex of the newest diagnosis message (6-255)
0x10F3:3	Newest Acknowledged Message	UINT8	RW	0	<p>Overwrite Mode (SI5, bit 4 = 0):</p> <p>Read = 0: When the message queue will be overwritten, the slave sets SI3 to 0.</p> <p>Writing = 0: The slave clears all messages, i.e. resets SI2, SI3, SI4 and SI5 bit 5*</p> <p>Writing = 1...5: The slave returns SDO abort with code 0x06090030 (Value range of parameter exceeded)</p> <p>Writing = 6..255: SI3 = written value (without checking)**</p> <p>Acknowledge Mode (SI5, bit 4 = 1):</p> <p>Read = 0: No messages have been acknowledged so far</p> <p>Read != 0: Subindex of latest acknowledged diagnosis message (6-69)</p> <p>Writing = 0: All acknowledged messages will be deleted</p> <p>Writing = 1...5: The slave returns SDO abort with code 0x06090032 (value of parameter written too low)</p> <p>Writing = 6...255: Messages are acknowledged***</p>
0x10F3:4	New Messages Available	BOOL	RO	0	<p>Overwrite Mode:</p> <ul style="list-style-type: none"> ■ 0: newest message was read

Index	Name	Type	Access	Default value	Significance
					<ul style="list-style-type: none"> ■ 1: newest message was not read Acknowledge mode: <ul style="list-style-type: none"> ■ 0: no unacknowledged message ■ 1: diagnosis messages are available
0x10F3:5	Flags	UINT2	RW	0x0000 (0dec)	Flags to control sending and storing of diagnosis messages Bit 0: Enable Emergency sending 0: default if device does not support emergency sending 1: new diagnosis messages shall be sent as emergency message <i>Bit 1: Disable info messages</i> 0: Info messages are stored in the diagnosis message queue (default) 1: Info messages will not be stored in the diagnosis message queue <i>Bit 2: Disable warning messages</i> 0: Warning messages are stored in the diagnosis message queue (default) 1: Warning messages will not be stored in the diagnosis message queue <i>Bit 3: Disable error messages</i> 0: Error messages are stored in the diagnosis message queue (default) 1: Error messages will not be stored in the diagnosis message queue <i>Bit 4: Mode selection for diagnosis history handling</i> 0: Overwrite Mode: old messages are overwritten by new ones when buffer is full

Index	Name	Type	Access	Default value	Significance
					<p>1: Acknowledge mode: New messages do only overwrite messages which were acknowledged before</p> <p><i>Bit 5: Overwrite/Discard Information (read only) In Overwrite mode:</i></p> <p>1: unacknowledged messages have been overwritten (= buffer overrun) (SI3 is set to 0, too) In Acknowledge mode:</p> <p>1: message buffer is full with acknowledged messages and a new message is discarded</p> <p><i>Bit 6.-15: reserved</i></p>
0x10F3: 6-255	Diagnosis Message	OCTET _STRING	RO		<p>Diagnosis message buffer.</p> <p>Depending on SI1 the EtherCAT slave can store up to 250 messages; the first message is stored in subindex 6, the second in subindex 7 and so on.</p> <p>When the queue is full, the EtherCAT slave shall overwrite subindex 6 and so on, that always the latest maximum messages (SI1) shall be accessible by the EtherCAT master.</p>

*) Messages are deleted even if they were not acknowledged or read before.

**) All messages up to the age of the message which is in the written subindex are acknowledged. The slave does not check if those messages have been read before. The slave returns SDO abort with code 0x06090030 (value range of parameter exceeded) in the following case: If SI3 is written with a value of a Subindex which does not hold a message.

**) All messages up to the age of the message which is in the written subindex are acknowledged. The slave does not check if those messages have been read before. The slave returns SDO abort with code 0x06090030 (value range of parameter exceeded) in the following case: If SI3 is written with a value of a Subindex which does not hold a message.

Subindex 0: Highest supported subindex

The diagnostic history can comprise a maximum of as many diagnostic messages as specified in subindex 1: Maximum Messages. These can be retrieved with subindex 6. Subindex 0 indicates the highest subindex a diagnostic message is stored at.

Subindex 1: Maximum Messages

The diagnostic history can comprise as many diagnostic messages as specified here. The maximum value is 250.

Subindex 2: Newest Message

Subindex 2 can be used to retrieve the subindex the latest diagnostic message is stored at in the diagnostic history. The value should be within 6 and 255. 0 is returned if actually there are no diagnostic messages saved.

Subindex 3: Newest Acknowledged Message

This subindex contains the subindex of the latest confirmed diagnostic message. It can be both read and written. In both cases, the value meaning is according to the current mode.

Available modes are

- Overwrite (overwrite mode, subindex 5, bit 4 = 0) and
- Acknowledge (acknowledge mode, subindex 5, bit 4 = 1).

Overwrite mode:

Read = 0:

If the diagnostic message queue has been overwritten, the EtherCAT slave sets subindex 3 to 0.

Writing = 0:

When writing 0 to subindex 3, the EtherCAT slave will delete subindex 2, subindex 3, subindex 4 and subindex 5 bit 5 respectively sets them to 0.

**INFO**

If if not previously acknowledged or read, diagnostic messages will be deleted.

Writing = 1...5:

Slave returns SDO abort with error code 0x06090032 (written parameter value too low).

Writing = 6...255:

Subindex 3 = Value is overwritten (without verification). Acknowledge mode:

Read = 0:

So far no diagnostic messages have been acknowledged (Acknowledge).

Read != 0:

Subindex of the last acknowledged diagnostic message (6-255) Writing = 0: Every acknowledged diagnostic message is being deleted.

Writing = 1...5:

Slave returns SDO Abort with error code 0x06090032 (written parameter value too low).

Writing = 6...255:

Diagnostic messages are acknowledged (Acknowledge).



INFO

All diagnostic messages up to the age of the message present in the recently written subindex are acknowledged (Acknowledge). The EtherCAT slave does not verify whether the diagnostic messages have previously been read.

When writing a subindex number without diagnostic message into subindex 3, message, the slave will return SDO Abort with error code 0x06090030 (parameter value range exceeded).

Subindex 4: New Messages Available

Overwrite mode:

0: The recent diagnostic message has been read.

1: The recent diagnostic message has not been read.

Acknowledge mode:

0: No diagnostic message that has not been acknowledged is present.

1: Diagnostic messages present to be acknowledged.

Subindex 5: Flags

Bit 0: Enable emergency messages	
0	Default if device cannot transmit emergency messages.
1	New diagnostic messages are transmitted as emergency messages.

Bit 1: Disable info messages	
0	Info messages are saved in the diagnostic message queue.
1	Info messages are not saved the diagnostic message queue.

Bit 2: Disable warning messages	
0	Warning messages are saved the diagnostic message queue.
1	Warning messages are not saved the diagnostic message queue

Bit 3: Disable error messages	
0	Error messages are saved in the diagnostic message queue.
1	Error messages are not saved in the diagnostic message queue.

Bit 4: Mode selection for reaction to buffer overflow in diagnostic history	
0	Overwrite mode: when buffer capacity is full, previous diagnostic messages are overwritten by new ones.
1	Acknowledge mode: Previous messages are only overwritten by new ones if previously having been acknowledged.

Bit 5: Overwrite and discard information (read only)	
In overwrite mode:	
1	Diagnostic messages not acknowledged are overwritten (= buffer overflow). Subindex 3 has been set to 0.

Bit 5: Overwrite and discard information (read only)	
In ac- knowl- edge mode:	
1	Diagnostic message buffer is full with acknowledged messages, reason why incoming diagnostic messages are discarded.

Subindex 6-255: Diagnosis Message

Subindex 6-255: Diagnosis message buffer

According to subindex 1, an EtherCAT slave can save up to 250 diagnostic messages. The first message is saved in subindex 6, the second in subindex 7 and so on.

When the buffer is full, the EtherCAT slave overwrites subindex 6 etc. so that recent diagnostic messages remain accessible to the EtherCAT master. Their exact number is specified in subindex 1.

9.4 Bit mapping and device process data

When used in a EtherCAT master system, the Baumer EtherCAT IO-Link master assigns such objects in the address area of the EtherCAT master. Process data come in the following structure:

TxPDO/RxPDO IO-Link slot Assignment

Process data assignment for digital channels or IO-Link device on pin 4.

- A slot being set to Digital IN or Digital OUT is assigned one byte of process data. The slot-specific status channel is available in the entire process data, i.e. in *TxPDO Mapping of digital Inputs* or *RxPDO Mapping of digital Outputs*.
- If the slot is set to IOL_x / y_I / O Byte, process data are assigned a certain number of bytes corresponding to the type (input/output) and size (x/y).

Input/output							
Byte 0	Byte 1	Byte 2					Byte 31
Process data byte 0	Process data byte 1	Process data byte 2	–	–	–	–	Process data byte 31

TxPDO Digital input assignment

Process data assignment to digital inputs on pin 4 and pin 2.

Pin4 (C/Q) + Pin2 (I/Q) - Port-based data layout

Eingangsbyte n							
Bit 0	Bit 1	Bit 2	Bit 3	Bit 4	Bit 5	Bit 6	Bit 7
Port X0 Pin 4	Port X0 Pin 2	Port X1 Pin 4	Port X1 Pin 2	Port X2 Pin 4	Port X2 Pin 2	Port X3 Pin 4	Port X3 Pin 2
Input byte n+1							
Bit 0	Bit 1	Bit 2	Bit 3	Bit 4	Bit 5	Bit 6	Bit 7

Eingangsbite n							
Port X4 Pin 4	Port X4 Pin 2	Port X5 Pin 4	Port X5 Pin 2	Port X6 Pin 4	Port X6 Pin 2	Port X7 Pin 4	Port X7 Pin 2

Tab. 7: Port-based data layout_digital inputs pin 4 and pin 2

Pin4 (C/Q) + Pin2 (I/Q) - Pin based data layout

Input byte n							
Bit 0	Bit 1	Bit 2	Bit 3	Bit 4	Bit 5	Bit 6	Bit 7
Port X0 Pin 4	Port X1 Pin 4	Port X2 Pin 4	Port X3 Pin 4	Port X4 Pin 4	Port X5 Pin 4	Port X6 Pin 4	Port X7 Pin 4
Input byte n+1							
Bit 0	Bit 1	Bit 2	Bit 3	Bit 4	Bit 5	Bit 6	Bit 7
Port X0 Pin 2	Port X1 Pin 2	Port X2 Pin 2	Port X3 Pin 2	Port X4 Pin 2	Port X5 Pin 2	Port X6 Pin 2	Port X7 Pin 2

Tab. 8: Pin-based data layout_digital inputs pin 4 and pin 2

TxPDO digital output assignment

Process data assignment to digital outputs on pin 4 and pin 2.

Pin4 (C/Q) + Pin2 (I/Q) - Port-based data layout

Input byte n							
Bit 0	Bit 1	Bit 2	Bit 3	Bit 4	Bit 5	Bit 6	Bit 7
Port X0 Pin 4	Port X0 Pin 2	Port X1 Pin 4	Port X1 Pin 2	Port X2 Pin 4	Port X2 Pin 2	Port X3 Pin 4	Port X3 Pin 2
Input byte n+1							
Bit 0	Bit 1	Bit 2	Bit 3	Bit 4	Bit 5	Bit 6	Bit 7
Port X4 Pin 4	Port X4 Pin 2	Port X5 Pin 4	Port X5 Pin 2	Port X6 Pin 4	Port X6 Pin 2	Port X7 Pin 4	Port X7 Pin 2

Tab. 9: Port-based data layout_digital inputs pin 4 and pin 2

Pin4 (C/Q) + Pin2 (I/Q) - Pin based data layout

Input byte n							
Bit 0	Bit 1	Bit 2	Bit 3	Bit 4	Bit 5	Bit 6	Bit 7
Port X0 Pin 4	Port X1 Pin 4	Port X2 Pin 4	Port X3 Pin 4	Port X4 Pin 4	Port X5 Pin 4	Port X6 Pin 4	Port X7 Pin 4
Input byte n+1							
Bit 0	Bit 1	Bit 2	Bit 3	Bit 4	Bit 5	Bit 6	Bit 7
Port X0 Pin 2	Port X1 Pin 2	Port X2 Pin 2	Port X3 Pin 2	Port X4 Pin 2	Port X5 Pin 2	Port X6 Pin 2	Port X7 Pin 2

Tab. 10: Pin-based data layout_digital inputs pin 4 and pin 2

TxPDO assignment of New available messages

Overwrite Mode	0: newest message was read
	1: newest message was not read
Acknowledge Mode	0: no unacknowledged message

1: diagnosis messages are available which can be acknowledged

TxPDO assignment of status data

One status byte available for each port.

State of IO-Link Port X_n:

Input byte n	0: Port disabled
	1: SIO mode digital input
	2: SIO mode digital output
	3: IO-Link communication enabled
	4: IO-Link communication disabled

State of IO-Link Port n_n (n represents the Subindex/Module position):

Bit 0...3 IO-Link State	0x00 (0dec)	Port Inactive
	0x01 (1dec)	Siomode Digital In
	0x02 (2dec)	Siomode Digital Out
	0x03 (3dec)	Communication OP
	0x04 (4dec)	Communication STOP
Bit 4...7 Error-Code	0x00 (0dec)	No Error
	0x10 (16dec)	Watchdog Error
	0x20 (32dec)	Buffer Overflow
	0x30 (48dec)	Invalid Device ID
	0x40 (64dec)	Invalid Vendor ID
	0x50 (80dec)	Invalid IO-Link Revision
	0x60 (96dec)	Invalid Frame Capability
	0x70 (112dec)	Invalid Cycle Time
	0x80 (128dec)	Invalid Length processdata
	0x90 (144dec)	Invalid Length processdata
	0xA0 (160dec)	No Device detected
	0xB0 (172dec)	Error PreOP

9.5 Distributed Clocks (DC)

Device supports transmission of DC messages and can act as a reference clock. Internal time stamps are limited to 32 bits.

Advanced Settings

- General
- Mailbox
- Distributed Clock
 - Assign to local μ C
 - Latch
- ESC Access

Distributed Clock

Cyclic Mode
 Operation Mode: Free Run
 Enable Sync Unit Cycle (μ s): 4000

SYNC 0
 Cycle Time (μ s):
 Sync Unit Cycle x 1 4000
 User Defined
 Enable SYNC 0

Shift Time (μ s):
 User Defined 0
 + SYNC0 Cycle x 0 0
 Based on Input Reference
 +
 = 0

SYNC 1
 Sync Unit Cycle Cycle Time (μ s): 4000
 SYNC 0 Cycle x 1 Shift Time (μ s): 0
 Enable SYNC 1

Use as potential Reference Clock

OK Abbrechen



INFO

Synchronization of the local device ports with DC id not provided.

9.6 Object directory

9.6.1 IO-Link master settings

Digital IO layout configuration:

Index	Name	Type	Access	Default	Significance
0x2001	PD Layout Configuration	UNIT8	RW	0	<ul style="list-style-type: none"> 0: Port-based 1: Pin-based



INFO

After device restart the changes made at the web server are adopted.

DO Substitute Configuration:

Index	Name	Type	Access	Default	Significance
0x2002:0	DO Substitute Configuration	RECORD			
0x2002:0	Highest supported subindex	UINT8	RO	1	

Index	Name	Type	Access	Default	Significance
0x2002:1	DO Substitute Mode	UINT8	RW	0	<ul style="list-style-type: none"> ■ 0: Off ■ 2: Hold last

9.6.2 IO-Link port settings

Digitale Ports

Index	Name	Type
0x2100	Configuration Port X0 Parameter	RECORD
0x2110	Configuration Port X1 Parameter	
0x2120	Configuration Port X2 Parameters	
0x2130	Configuration of port X3 parameters	
0x2140	Configuration of port X4 parameters	
0x2150	Configuration Port X5 parameters	
0x2160	Configuration of port X6 parameters	
0x2170	Configuration Port X7 Parameters	

Tab. 11: IO-Link-Port Class A/B



INFO

Parameter 0x21n0 (n = ports X0 ... X7).

DO Substitute Configuration:

Index	Name	Type	Access	Default	Significance
0x21n:00	Port Xn Parameter	UNIT8	RO	5	
0x21n:01	Pin 4 (C/Q)	BOOL	RW	FALSE	<ul style="list-style-type: none"> ■ 0x00 (0dec) Digital Input (NO) ■ 0x01 (1dec) Digital Input inverted (NC)
0x21n0.2	Digital input filter Pin 4 (C/Q)	UINT8	RW	0x00	<ul style="list-style-type: none"> ■ 0x00 (0dec) No filter ■ 0x0A (10dec) 1ms filter ■ 0x1E (30dec) 3ms filter ■ 0x32 (50dec) 5ms filter ■ 0x64 (100dec) 10ms filter ■ 0x96 (150dec) 15ms filter
0x21n0.3	Reserved	–	–	–	–
0x21n0.4	Digital Mode Pin2 (I/Q)	UINT8	RW	0x04 (4dec)	<ul style="list-style-type: none"> ■ 0x00 (0dec) Digital Input (NO) ■ 0x01 (1dec) Digital Input inverted (NC) ■ 0x02 (2dec) Digital Output ■ 0x03 (3dec) Static ON (24V) ■ 0x04 (4dec) Deaktiviert
0x21n0.5	Digital Input Filter Pin2 (I/Q)	UINT8	RW	0x0A (10dec)	<ul style="list-style-type: none"> ■ 0x00 (0dec) = No filter ■ 0x0A (10dec) = 1 ms filter

Index	Name	Type	Access	Default	Significance
					<ul style="list-style-type: none"> ■ 0x1E (30dec) = 3 ms filter ■ 0x32 (50dec) = 5 ms filter ■ 0x64 (100dec) = 10 ms filter ■ 0x96 (150dec) = 15 ms
0x21n0.6	IO-Link Process Data Swap	UINT8	RW	0	<ul style="list-style-type: none"> ■ 0 = No Swap ■ 1 = 16 Bit Swap <ul style="list-style-type: none"> ■ <i>In case of odd data length the last byte will not be touched</i> ■ 2 = 32 Bit Swap <ul style="list-style-type: none"> ■ <i>In case the data length is not on 4 byte boundary</i> <ul style="list-style-type: none"> ▪ 3 byte, swap of byte x with x+2. x+1 will not be touched ▪ 3 byte, swap of byte x with x+2. x+1 will not be touched ▪ 1 byte, byte will not be touched ■ 3 = Full Swap

9.6.3 Device reset

Firmware Update

Index	Name	Type	Access	Default	Significance
0x5FFF	Reset to Factory	UNIT8	WO	–	<ul style="list-style-type: none"> ■ 1: Device Config ■ 2: Network Config ■ 3: Application Config ■ 4: Factory reset

9.7 Industrial Internet of Things (IIoT)

9.7.1 JSON

JSON standard settings

No.	REST API URL	Description	Supporting
1	GET /iolink/v1/gateway/identification	Identification of the gateway	Yes
2	GET /iolink/v1/gateway/capabilities	Capabilities of the gateway	Yes
3	GET /iolink/v1/gateway/configuration	Read network configuration of the gateway	Yes
4	POST /iolink/v1/gateway/configuration	Write network configuration of the gateway	Yes
5	POST /iolink/v1/gateway/reset	Reset the gateway including all masters	-
6	POST /iolink/v1/gateway/reboot	Reboot the gateway including all masters	-

No.	REST API URL	Description	Supporting
7	GET /iolink/v1/gateway/events	Event log containing all events from gateway, masters, ports, and devices	Yes
8	GET /iolink/v1/masters	Get all available master number keys and identification information	Yes
9	GET /iolink/v1/masters/\$MASTER_NUMBER/capabilities	Capabilities of the master	Yes
10	GET /iolink/v1/masters/\$MASTER_NUMBER/identification	Read identification of the master	Yes
11	POST /iolink/v1/masters/\$MASTER_NUMBER/identification	Write identification of the master	Yes
12	GET /iolink/v1/masters/\$MASTER_NUMBER/ports	Get all available port number keys	Yes
13	GET /iolink/v1/masters/\$MASTER_NUMBER/ports/\$PORT_NUMBER/capabilities	Read capability information of the specified port	Yes
14	GET /iolink/v1/masters/\$MASTER_NUMBER/ports/\$PORT_NUMBER/status	Read status of the master	Yes
15	GET /iolink/v1/masters/\$MASTER_NUMBER/ports/\$PORT_NUMBER/configuration	Read configuration of the specified port	Yes
16	POST /iolink/v1/masters/\$MASTER_NUMBER/ports/\$PORT_NUMBER/configuration	Write configuration of the specified port	Yes
17	GET /iolink/v1/masters/\$MASTER_NUMBER/ports/\$PORT_NUMBER/datastorage	Read data storage content of the specified port	Yes
18	POST /iolink/v1/masters/\$MASTER_NUMBER/ports/\$PORT_NUMBER/datastorage	Write data storage content of the specified port	Yes
19	GET /iolink/v1/devices	Address all devices of all masters	Yes
20	GET /iolink/v1/devices/{deviceAlias}/capabilities	Read capability information of the specified device	Yes
21	GET /iolink/v1/devices/{deviceAlias}/identification	Read identification information of the specified device	Yes
22	POST /iolink/v1/devices/{deviceAlias}/identification	Write identification information of the specified device	-
23	GET /iolink/v1/devices/{deviceAlias}/processdata/value?format=byteArray	Read process data value from the specified device	Yes
24	GET /iolink/v1/devices/{deviceAlias}/processdata/getdata/value?format=byteArray	Read process data input value from the specified device	Yes

No.	REST API URL	Description	Supporting
25	GET /iolink/v1/devices/{deviceAlias}/processdata/ setdata/value?format=byteArray	Read process data output value from the specified device	Yes
26	POST /iolink/v1/devices/{deviceAlias}/processdata/ value	Write the process data output value to the specified device	Yes
27	GET /iolink/v1/devices/{deviceAlias}/parameters/ {index}/value/?format=byteArray	Read a specific parameter value and its sub-parameter values (if the parameter has complex type) with the given index of the device	Yes
28	GET /iolink/v1/devices/{deviceAlias}/parameters/ {index}/subindices/ {subindex}/value/?format= byteArray	Read the value of a specific sub-parameter with the given index and subindex	Yes
29	GET /iolink/v1/devices/{deviceAlias}/parameters/{parameterName}/value/?format=byteArray	Read a specific parameter value with the given name	-
30	POST /iolink/v1/devices/{deviceAlias}/parameters/ {index}/value	Write the parameter with the given index to the device	Yes
31	POST /iolink/v1/devices/{deviceAlias}/parameters/ {parameterName}/value	Write the parameter with the given name to the device	-
32	POST /iolink/v1/devices/{deviceAlias}/parameters/ {index}/subindices/{subindex}/value	Write the sub-parameter with the given index and subindex to the device	Yes
33	POST /iolink/v1/devices/{deviceAlias}/parameters/ {parameterName}/subindices/{subParameterName}/ value	Write the sub-parameter with the given parameter name and sub-parameter name to the device	-
34	POST /iolink/v1/devices/{deviceAlias}/ blockparametrization/?format=byteArray	Read or write one or more parameters as a block	Yes
35	GET /iolink/v1/devices/{deviceAlias}/events	Read event log from the specified device	Yes
36	GET /iolink/v1/mqtt/configuration	Read configuration of MQTT clients	Yes
37	POST /iolink/v1/mqtt/configuration	Write configuration of MQTT clients	-
38	GET /iolink/v1/mqtt/topics	Read list of MQTT topics	-
39	POST /iolink/v1/mqtt/topics	Write list of MQTT topics	-
40	DELETE /iolink/v1/mqtt/topics/{topicID}	Delete a specific MQTT topic	-
41	GET /iolink/v1/mqtt/topics/{topicID}	Read a specific MQTT topic	-
42	GET /iolink/v1/mqtt/connectionstatus	Read connection status	Yes

Vendor-specific JSON settings

No.	REST API URL	Description	Supporting
43	GET /iolink/v1/vendor/masters/ \$MASTER_NUMBER/diagnostics/ configuration	Diagnostic configuration of the master	Yes
44	GET /iolink/v1/vendor/masters/ \$MASTER_NUMBER/diagnostics/ value	Diagnostic values of the master	Yes
45	GET /iolink/v1/vendor/masters/ \$MASTER_NUMBER/ports/ \$PORT_NUMBER/ statistics/current	Current statistic values of the specified port of the master	Yes
46	GET /iolink/v1/vendor/masters/ \$MASTER_NUMBER/ports/ \$PORT_NUMBER/ statistics/voltage	Voltage statistic values of the specified port of the master	Yes
47	GET /iolink/v1/vendor/masters/ \$MASTER_NUMBER/ports/ \$PORT_NUMBER/ statistics/temper- ature	Temperature statistic values of the specified port of the master	Yes
48	GET /iolink/v1/vendor/masters/1/ ports/1/statistics/ stack	IO-Link stack statistic values of the specified port of the master	-
49	GET /iolink/v1/vendor/masters/ \$MASTER_NUMBER/ports/ \$PORT_NUMBER/ diagnostics/con- figuration	Diagnostic configuration of the specified port of the master	Yes
50	GET /iolink/v1/vendor/masters/ \$MASTER_NUMBER/ports/ \$PORT_NUMBER/ diagnostics/cur- rent	Diagnostic current value of the specified port of the master	Yes
51	GET /iolink/v1/vendor/masters/ \$MASTER_NUMBER/ports/ \$PORT_NUMBER/ diagnostics/volt- age	Diagnostic voltage value of the specified port of the master	Yes
52	GET /iolink/v1/vendor/masters/ \$MASTER_NUMBER/ports/ \$PORT_NUMBER/ diagnostics/tem- perature	Diagnostic temperature value of the specified port of the master	Yes

9.7.2 MQTT



INFO

If MQTT is enabled, mandatory that JSON is activated as well.

MQTT settings

No.	MQTT topics	Description
1	\$MQTT_CLIENT_HEAD_TOPIC /iolink/v1/gateway/ identification	Identification of the gateway
2	\$MQTT_CLIENT_HEAD_TOPIC /iolink/v1/gateway/ capabilities	Capabilities of the gateway
3	\$MQTT_CLIENT_HEAD_TOPIC /iolink/v1/gateway/ configuration	Network configuration of the gateway
4	\$MQTT_CLIENT_HEAD_TOPIC /iolink/v1/masters	Get all available master number keys and identification information
5	\$MQTT_CLIENT_HEAD_TOPIC /iolink/v1/masters/\$MASTER_NUMBER/diagnostics/ value	Diagnostic values of the master
6	\$MQTT_CLIENT_HEAD_TOPIC /iolink/v1/masters/\$MASTER_NUMBER/diagnostics/ configuration	Diagnostic configuration of the master
7	\$MQTT_CLIENT_HEAD_TOPIC /iolink/v1/masters/\$MASTER_NUMBER/capabilities	Capabilities of the master
8	\$MQTT_CLIENT_HEAD_TOPIC /iolink/v1/masters/\$MASTER_NUMBER/identification	Identification of the master
9	\$MQTT_CLIENT_HEAD_TOPIC /iolink/v1/masters/\$MASTER_NUMBER/ports	Get all available port number keys
10	\$MQTT_CLIENT_HEAD_TOPIC /iolink/v1/masters/\$MASTER_NUMBER/ports/\$PORT_NUMBER/capabilities	Read capability information of the specified port
11	\$MQTT_CLIENT_HEAD_TOPIC /iolink/v1/masters/\$MASTER_NUMBER/ports/\$PORT_NUMBER/status	Read actual status of the specified port
12	\$MQTT_CLIENT_HEAD_TOPIC /iolink/v1/masters/\$MASTER_NUMBER/ports/\$PORT_NUMBER/configuration	Read/Write configuration of the specified port
13	\$MQTT_CLIENT_HEAD_TOPIC /iolink/v1/masters/\$MASTER_NUMBER/ports/\$PORT_NUMBER/diagnostics/ configuration	Diagnostic configuration of the specified port of the master
14	\$MQTT_CLIENT_HEAD_TOPIC /iolink/v1/masters/\$MASTER_NUMBER/ports/\$PORT_NUMBER/diagnostics/ current	Diagnostic current value of the specified port of the master
15	\$MQTT_CLIENT_HEAD_TOPIC /iolink/v1/masters/\$MASTER_NUMBER/ports/\$PORT_NUMBER/diagnostics/ voltage	Diagnostic voltage value of the specified port of the master

No.	MQTT topics	Description
16	\$MQTT_CLIENT_HEAD_TOPIC /iolink/v1/masters/\$MASTER_NUMBER/ports/\$PORT_NUMBER/diagnostics/ temperature	Diagnostic temperature value of the specified port of the master
17	\$MQTT_CLIENT_HEAD_TOPIC /iolink/v1/masters/\$MASTER_NUMBER/ports/\$PORT_NUMBER/statistics/ current	Current statistic values of the specified port of the master
18	\$MQTT_CLIENT_HEAD_TOPIC /iolink/v1/masters/\$MASTER_NUMBER/ports/\$PORT_NUMBER/statistics/ voltage	Voltage statistic values of the specified port of the master
19	\$MQTT_CLIENT_HEAD_TOPIC/iolink/v1/masters/\$MASTER_NUMBER/ports/\$PORT_NUMBER/statistics/ temperature	Temperature statistic values of the specified port of the master
20	\$MQTT_CLIENT_HEAD_TOPIC /iolink/v1/devices/\$DEVICE_ALIAS/processdata/value	Read/Write process data value from/to the specified device
21	\$MQTT_CLIENT_HEAD_TOPIC /iolink/v1/devices/\$DEVICE_ALIAS/processdata/getdata/value	Read process data input value from the specified device
22	\$MQTT_CLIENT_HEAD_TOPIC /iolink/v1/devices/\$DEVICE_ALIAS/processdata/setdata/value	Read process data output value from the specified device
23	\$MQTT_CLIENT_HEAD_TOPIC /iolink/v1/devices/\$DEVICE_ALIAS/events	Read event log from the specified device
24	\$MQTT_CLIENT_HEAD_TOPIC /Asset	Information about the publisher (network, vendor, firmware)
25	\$MQTT_CLIENT_HEAD_TOPIC /Online	Status of the publisher (online when connected)

9.7.3 OPC UA



INFO

The devices shown in the screenshots serve as examples.

The device features OPC UA server. The OPC UA client can establish a connection to the device for access to the following parameters:

- Device identification,
- configuration parameters,
- process data,
- measured values,
- diagnostic information,
- statistical information, etc.

The OPC UA client establishes connection using the following URL:

opc.tcp://IP-Adresse:4840



INFO

The IP address of the device is used for **IP address** .

9.7.3.1

OPC UA PC Client

The device integrates OPC UA server. The OPC UA client is for device communication.

For test purposes, you can use *UaExpert* from *Unified Automation GmbH*, for example: <https://www.unifiedautomation.com>.

The OPC UA client has read access to the device using the authentication “Anonymous”. The OPC UA client has read and write access to the device using the authentication “User name and Password”, provided the related user has write rights.

Conneting to CM50I.PN

Condition:

- ⇒ You have OPC UA client.
- ⇒ For write access to the device, you need to know user name, password and have write access.
- ⇒ You know the device IP address.

Instruction:

- a) Start *UaExpert*.
- b) Create a new project via **File > New**.
- c) Add new server by selecting **Server r > Add**.

Result:

- ✓ Dialog window **Add Server** is shown in tab **Discovery**.

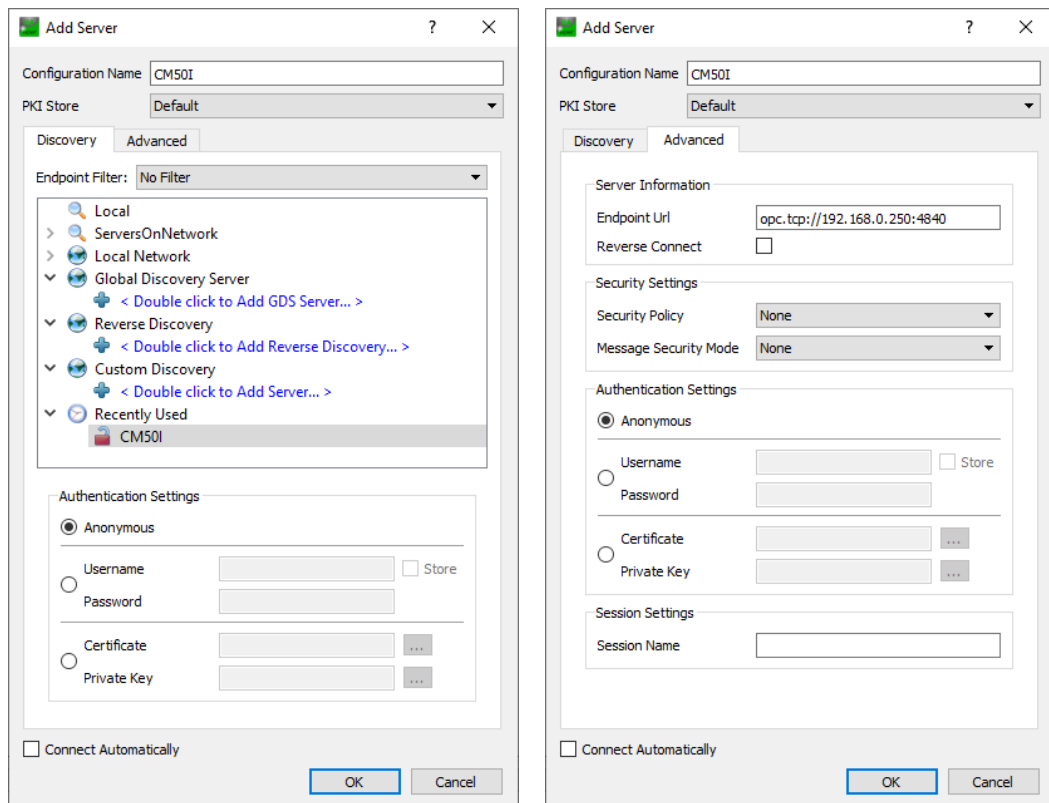

III. 29: Dialog window Add Server – tabs Discovery and Advanced

- a) In field **Configuration Name** enter a name for the configuration, e.g. `Test`.
- b) Select tab **Advanced**.
- c) In the **Server Information** area of the **Advanced** tab, enter the following in the **Endpoint Url** data field:
`opc.tcp://<IP address>:4840`
 Enter the IP address of the device for `<IP address>`.
- d) In the **Authentication Settings** area, select the option **Username/ Password** if you want write access to the device or **Anonymous** if read access is sufficient.
- e) If you have selected option **Username/Password**, enter your user name and your password.
- f) Click **OK**.
 - ✓ In the project window, *UaExpert* enters the server under **Project > Servers** with the selected name.
- g) Open server context menu (`Test` in the example) and select **Connect**.

Result:

- ✓ The connection is being established.





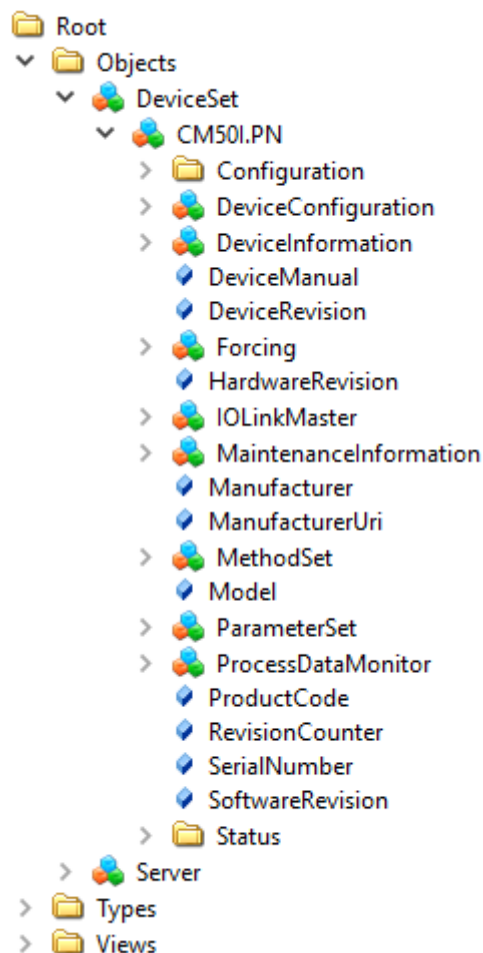





















Client can access device parameters anonymously (read only) or with user name/password (read and write). User name and password are entered via web server.

The following figure shows an excerpt of the device information model.



III. 30: OPC-UA-Server - Device information model

The following figure shows an excerpt of an IO-Link port information model.

- ▼  Port X7
 - >  Alarms
 - >  Capabilities
 - >  Configuration
 - ▼  Device
 - >  Alarms
 - ◆ DeviceAccessLocks
 - >  DeviceHealth
 - ◆ DeviceID
 - >  General
 - ◆ HardwareRevision
 - >  Identification
 - ◆ Manufacturer
 - >  MethodSet
 - ◆ MinCycleTime
 - ◆ Model
 - ◆ NodeVersion
 - >  ParameterSet
 - ◆ ProductID
 - ◆ ProductText
 - ◆ ProfileCharacteristic
 - ◆ RevisionID
 - ◆ SerialNumber
 - ◆ SoftwareRevision
 - ◆ VendorID
 - ◆ VendorText
 - ◆ DeviceConfigurationDisabled
 - ▼  Diagnostics
 - >  Configuration
 - ▼  Current
 - >  CurrentPin1
 - >  CurrentPin2
 - >  CurrentPin4
 - >  Flags
 - >  Temperature
 - >  Voltage
 - >  Information
 - >  MethodSet
 - ◆ NodeVersion
 - >  ParameterSet
 - ▼  SIOProcessData
 - >  Pin2ProcessData
 - >  Statistics
 - >  Statistics
 - ◆ VendorID

III. 31: OPC-UA-Server - Port information model

9.7.3.2 Authentication

User log on

OPC UA use the same users and passwords as those documented in the web server description.

OPC UA server connection is established via user **guest** allowing read access to the OPC UA objects.

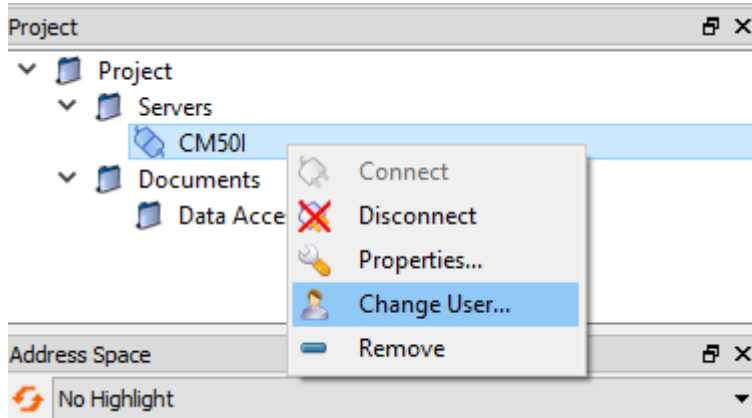

III. 32: Changing the user

For further actions, another user must be selected.

Instruction:

- a) User name **<admin>**
- b) Password **<private>**

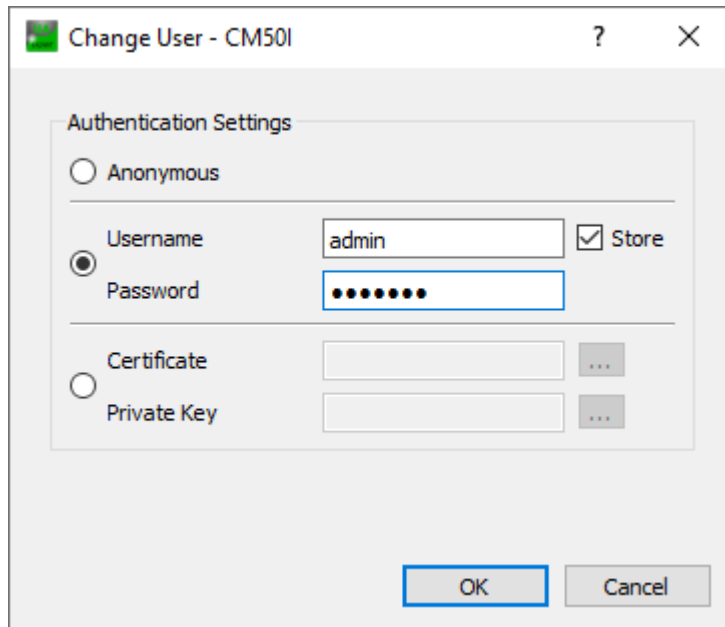

III. 33: User name and password

Forcing

Digital outputs enable manual switching via OPC UA(Forcing).

Step 1

Create an ID from the device using the *GetForcingID* method.

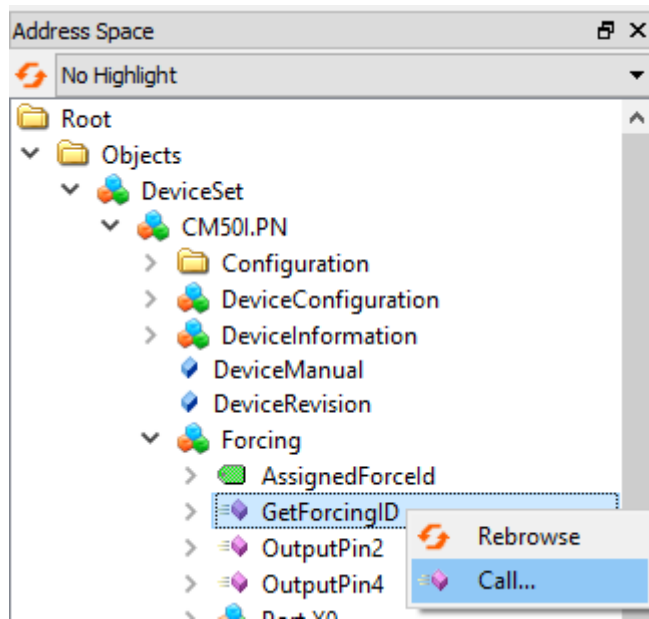

III. 34: Accessing *GetForcingID*-Methode

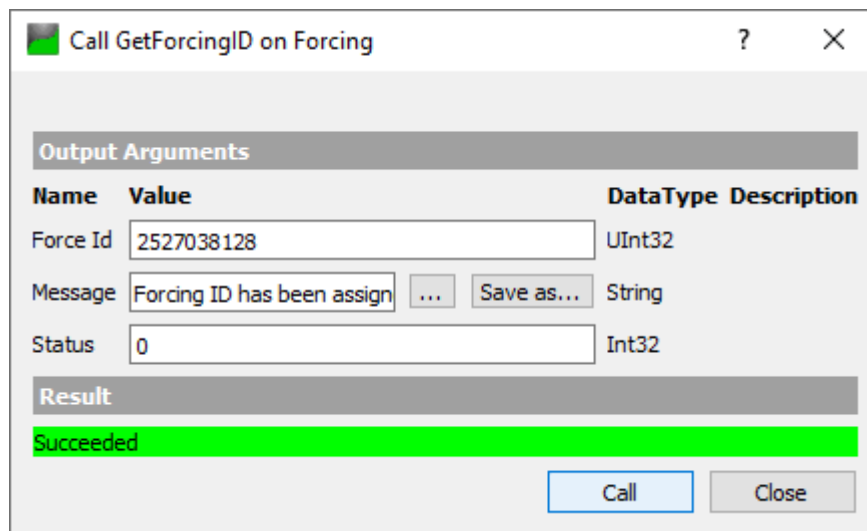

III. 35: Dialog window of the *GetForcingID* method



INFO

ForcingID is only valid for 10 seconds. Every access to *Forcing* will refresh validity to another 10 seconds.

Step 2

Set the digital outputs using methods *OutputPin2* respectively *OutputPin4*.

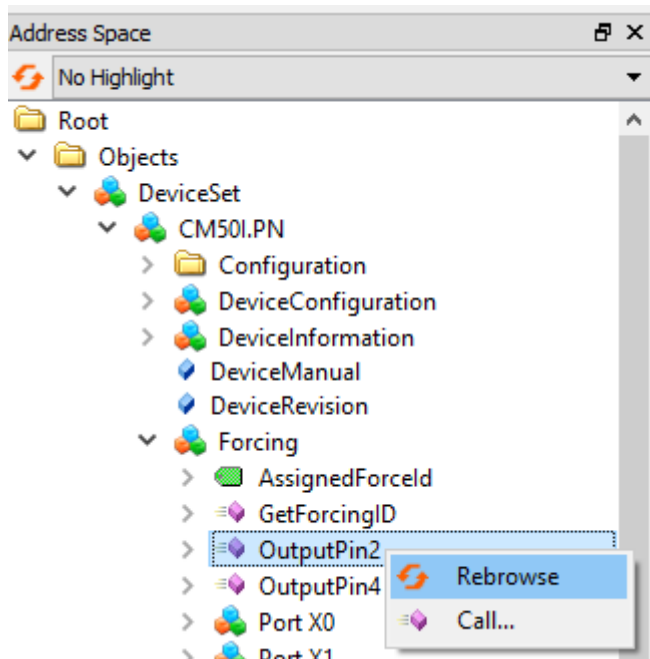

Ill. 36: Accessing method *OutputPin2*

This method expects as parameters the included *Forcing ID*, a bit mask and the data to be written.

9.7.3.3 Device identification

The device provides nodes for device identification. From this node, the *OPC UA* client for example will read the applied device firmware revision.

Node ID	Node class	Access	Description
Manufacturer	Variable	read	Device manufacturer
ManufacturerUri	Variable	read	Device manufacturer URL
Model	Variable	read	Device model designation
ProductCode	Variable	read	Device product code
RevisionCounter	Variable	read	Device Hardware Revision
SerialNumber	Variable	read	Device serial number
SoftwareRevision	Variable	read	Device firmware revision

Tab. 12: Device identification

#	Server	Node Id	Display Name	Value	Datatype
1	CM50I	NS6 Numeric 161	Manufacturer	"en", "Baumer"	LocalizedText
2	CM50I	NS6 Numeric 166	ManufacturerUri	www.baumer.com	String
3	CM50I	NS6 Numeric 162	Model	"en", "CM50I.PN"	LocalizedText
4	CM50I	NS6 Numeric 167	ProductCode	11261571	String
5	CM50I	NS6 Numeric 163	RevisionCounter	1	Int32
6	CM50I	NS6 Numeric 164	SerialNumber	6040000002979658	String
7	CM50I	NS6 Numeric 165	SoftwareRevision	V1.3.0	String

Ill. 37: Device identification

9.7.3.4 Configuration parameters

The *OPC UA* server provides nodes with device configuration parameters. For example, in node **OverTemperature** the *OPC UA* client can read out the maximum temperature limit.

Node ID	Node class	Access	Default	Description
CurrentHysteresis	Variable	read	10 mA	Current hysteresis, unit: mA If the limit is exceeded by current, current must first drop below again by the hysteresis value to cancel diagnostics.
OverTemperature	Variable	read	70 °C	Maximum limit for port temperature, unit: 0.1 °C
OverVoltageL	Variable	read	30 V	Maximum power limit assigned to supply line 1 enabling monitoring of pins L+, DI, DO, DIO, IO-Link. Unit: mV
OverVoltageL2	Variable	read	30 V	Maximum power limit assigned to supply line 2, unit: mV
TemperatureHysteresis	Variable	read	2 °C	Temperature hysteresis, unit: 0.1 °C If the limit is exceeded by temperature, temperature must first drop below again by the hysteresis value to cancel diagnostics.
UnderTemperature	Variable	read	-25 °C	Minimum limit for port temperature, unit: 0.1°C°

Node ID	Node class	Access	Default	Description
UnderVoltage L	Variable	read	18 V	Minimum power limit assigned to supply line 1 enabling monitoring of pins L+, DI, DO, DIO, IO-Link. Unit: mV
UnderVoltage L2	Variable	read	18 V	Minimum power limit assigned to supply line 2, unit: mV
Voltage Hysteresis	Variable	read	300 mV	Voltage hysteresis, unit: mV If the limit is exceeded by voltage, voltage must first drop below again by the hysteresis value to cancel diagnostics.

Tab. 13: Device specific configuration parameters

#	Server	Node Id	Display Name	Value	Datatype
1	CM50I	NS6 Numeric 2057	CurrentHysteresis	10	UInt16
2	CM50I	NS6 Numeric 2050	OverTemperature	70	Float
3	CM50I	NS6 Numeric 2058	OverVoltageL	30000	Int32
4	CM50I	NS6 Numeric 2059	OverVoltageL2	30000	Int32
5	CM50I	NS6 Numeric 2051	TemperatureHyster...	2	Float
6	CM50I	NS6 Numeric 2049	UnderTemperature	-25	Float
7	CM50I	NS6 Numeric 2060	UnderVoltageL	17000	Int32
8	CM50I	NS6 Numeric 2061	UnderVoltageL2	17000	Int32
9	CM50I	NS6 Numeric 2062	VoltageHysteresis	300	UInt16

III. 38: Device specific configuration parameters

Node ID	Node class	Access	Default	Description
OverCurrentPin1, OverCurrentPin2, OverCurrentPin4	Variable	read	0	Warning level for maximum current limit at pin 1, pin 2 or pin 4, unit: 1mA

Node ID	Node class	Access	Default	Description
UnderCurrent-Pin1, UnderCurrent-Pin2, UnderCurrentPin4	Variable	read	0	Warning level for minimum current limit at pin 1, pin 2 or pin 4, unit: 1mA 0: monitoring not enabled

Tab. 14: Port-specific configuration parameters

#	Server	Node Id	Display Name	Value	Datatype
1	CM50I	NS6 Numeric 34860	OverCurrentPin1	0	Int32
2	CM50I	NS6 Numeric 34862	OverCurrentPin2	0	Int32
3	CM50I	NS6 Numeric 34864	OverCurrentPin4	0	Int32
4	CM50I	NS6 Numeric 34861	UnderCurrentPin1	0	Int32
5	CM50I	NS6 Numeric 34863	UnderCurrentPin2	0	Int32
6	CM50I	NS6 Numeric 34865	UnderCurrentPin4	0	Int32

III. 39: Port-specific configuration parameters

9.7.3.5 Process data

The *OPC UA* server provides nodes including process data. For example, in node **Pin2ProcessData** the *OPC UA* client can read out a port value provided at pin 2.

Node ID	Node class	Access	Description
Pin2ProcessData	Variable	read	Process data at pin 2
Pin4ProcessData	Variable	read	Process data at pin 4

Tab. 15: Process data

#	Server	Node Id	Display Name	Value
1	CM50I	NS6 Numeric 33340	Pin2ProcessData	false
2	CM50I	NS6 Numeric 33341	Pin4ProcessData	false

III. 40: Process data

9.7.3.6 Measured values

The *OPC UA* server provides nodes with calculated measured values. For example, in node **SumCurrentL** the *OPC UA* client can read in calculated total current of supply line 1.

Node ID	Node class	Access	Description
SumCurrentL	Variable	read	The total current calculated from individual measurements in supply line 1, unit: mA
SumCurrentL2	Variable	read	The total current calculated from individual measurements in supply line 2, unit: mA
MeanTemperature	Variable	read	Average temperature value assigned to the component, calculated from each temperature value individually measured at the three chips. Unit: °C
MeanVoltageL	Variable	read	Average voltage in supply line 1, unit: mV
MeanVoltageL2	Variable	read	Average voltage in supply line 2, unit: mV

Tab. 16: Device-specific (calculated) measured values

#	Server	Node Id	Display Name	Value	Datatype
1	CM50I	NS6 Numeric 2052	SumCurrentL	114	Int32
2	CM50I	NS6 Numeric 2053	SumCurrentL2	0	Int32
3	CM50I	NS6 Numeric 2054	MeanTemperature	34.6	Float
4	CM50I	NS6 Numeric 2055	MeanVoltageL	24037	Int32
5	CM50I	NS6 Numeric 2056	MeanVoltageL2	24180	Int32

III. 41: Device-specific (calculated) measured values

Node ID	Node class	Access	Description
CurrentPin1, CurrentPin2, CurrentPin4	Variable	read	Current measured at pin 1, pin 2 or pin 4, unit: mA
TemperaturePin1, TemperaturePin2, TemperaturePin4	Variable	read	Temperature measured at pin 1, pin 2 or pin 4, unit: °C
VoltagePin1, VoltagePin2, VoltagePin4	Variable	read	Voltage measured at pin 1, pin 2 or pin 4, unit: mA

Tab. 17: Port specific measuring values

#	Server	Node Id	Display Name	Value	Datatype
1	CM50I	NS6 Numeric 34836	CurrentPin1	31	Int32
2	CM50I	NS6 Numeric 34837	CurrentPin2	0	Int32
3	CM50I	NS6 Numeric 34838	CurrentPin4	0	Int32
4	CM50I	NS6 Numeric 34854	MaxTemperaturePin1	36.7	Float
5	CM50I	NS6 Numeric 34855	MaxTemperaturePin2	36.7	Float
6	CM50I	NS6 Numeric 34856	MaxTemperaturePin4	36.7	Float
7	CM50I	NS6 Numeric 34851	MinVoltagePin1	24022	Int32
8	CM50I	NS6 Numeric 34852	MinVoltagePin2	-162	Int32
9	CM50I	NS6 Numeric 34853	MinVoltagePin4	-153	Int32

III. 42: Port specific measuring values

9.7.3.7 Diagnostic tools

The *OPC UA* server provides nodes with diagnostic information. In node ***DiagnosticsPin1***, the *OPC UA* client can read whether the device has identified presence of any over current at pin 1 of a port.

Node ID	Node class	Access	Description
DiagnosticsPin1, DiagnosticsPin2, DiagnosticsPin4	Variable	read	Diagnostics on pin 1, pin 2 or pin 4. The numerical value contains bit-coded information: <ul style="list-style-type: none"> ■ Bit 0: Short circuit, ■ Bit 1: Overload protection, ■ Bit 2: Overtemperature protection, ■ Bit 3: Overvoltage protection, ■ Bit 4: Overcurrent, ■ Bit 5: Undercurrent ■ Bit 0: Overtemperature ■ Bit 1: Undertemperature ■ Bit 2: Overvoltage ■ Bit 3: Undervoltage

Node ID	Node class	Access	Description
			<ul style="list-style-type: none"> Bit 4: Watchdog 0: Diagnosis not active 1: Diagnosis active

Tab. 18: Port-specific diagnostics

#	Server	Node Id	Display Name	Value	Datatype
1	CM50I	NS6 Numeric 34839	DiagnosticsPin1	0	Int32
2	CM50I	NS6 Numeric 34840	DiagnosticsPin2	0	Int32
3	CM50I	NS6 Numeric 34841	DiagnosticsPin4	0	Int32

III. 43: Port-specific diagnostics

9.7.3.8 Statistics

The OPC UA server provides nodes with statistical information. In node **MaxCurrentPin1**, the OPC UA client can read at pin 1 of a port the maximum measured current.

Node ID	Node class	Access	Description
Current			
MaxCurrentPin1, MaxCurrentPin2, MaxCurrentPin4	Variable	read	Maximum current at pin 1, pin 2 or pin 4 since value reset, unit: mA
MinCurrentPin1, MinCurrentPin2, MinCurrentPin4	Variable	read	Minimum current at pin 1, pin 2 or pin 4 since value reset, unit: mA
Temperature			
MaxTemperaturePin1, MaxTemperaturePin2, MaxTemperaturePin4	Variable	read	Maximum temperature at pin 1, pin 2 or pin 4 since value reset, unit: °C

Node ID	Node class	Access	Description
MinTemperaturePin1, MinTemperaturePin2, MinTemperaturePin4	Variable	read	Minimum temperature at pin 1, pin 2 or pin 4 since value reset, unit: °C
Voltage			
MaxVoltagePin1, MaxVoltagePin2, MaxVoltagePin4	Variable	read	Maximum voltage at pin 1, pin 2 or pin 4 since value reset, unit: mV
MinVoltagePin1, MinVoltagePin2, MinVoltagePin4	Variable	read	Minimum voltage at pin 1, pin 2 or pin 4 since value reset, unit: mV

Tab. 19: Port specific statistical information

#	Server	Node Id	Display Name	Value	Datatype
1	CM50I	NS6 Numeric 34842	MaxCurrentPin1	38	Int32
2	CM50I	NS6 Numeric 34843	MaxCurrentPin2	10	Int32
3	CM50I	NS6 Numeric 34844	MaxCurrentPin4	0	Int32
4	CM50I	NS6 Numeric 34845	MinCurrentPin1	9	Int32
5	CM50I	NS6 Numeric 34846	MinCurrentPin2	0	Int32
6	CM50I	NS6 Numeric 34847	MinCurrentPin4	0	Int32
7	CM50I	NS6 Numeric 34854	MaxTemperaturePin1	36.7	Float
8	CM50I	NS6 Numeric 34855	MaxTemperaturePin2	36.7	Float
9	CM50I	NS6 Numeric 34856	MaxTemperaturePin4	36.7	Float
10	CM50I	NS6 Numeric 34857	MinTemperaturePin1	28.8	Float
11	CM50I	NS6 Numeric 34858	MinTemperaturePin2	28.8	Float
12	CM50I	NS6 Numeric 34859	MinTemperaturePin4	28.8	Float
13	CM50I	NS6 Numeric 34848	MaxVoltagePin1	24068	Int32
14	CM50I	NS6 Numeric 34849	MaxVoltagePin2	23545	Int32
15	CM50I	NS6 Numeric 34850	MaxVoltagePin4	23111	Int32
16	CM50I	NS6 Numeric 34851	MinVoltagePin1	24022	Int32
17	CM50I	NS6 Numeric 34852	MinVoltagePin2	-162	Int32
18	CM50I	NS6 Numeric 34853	MinVoltagePin4	-153	Int32

III. 44: Port specific statistical information

9.7.3.9 NTP client configuration

The *OPC UA* server provides nodes for NTP client configuration.

Node ID	Node class	Access	Description
NtpClientServerIpAddress	Variable	Read / Write	<ul style="list-style-type: none"> ■ NTP server IP address ■ The NTP client uses the set IP address for retrieving the time information from the NTP server. ■ The IP address must be converted into a decimal number. The table shows how to convert. ■ Value 0 disables the function.
NtpClientServerIpAddressFallback	Variable	Read / Write	<ul style="list-style-type: none"> ■ IP address of the NTP server (fallback) ■ The optional IP address if the NTP server is not accessible via the IP address in node NtpClientServerIpAddress. ■ The IP address must be converted into a decimal number. The table shows how to convert. ■ Value 0 disables the function.
NtpClientUpdateConfiguration	Variable	Write	Method for writing the nodes NtpClientServerIpAddress and NtpClientServerIpAddressFallback

Tab. 20: NTP client configuration

The following formula is used to convert the IP address into a decimal number. Starting from an IP address in the format **A.B.C.D**:

$$((A * 256 + B) * 256 + C) * 256 + D = \text{IP address converted into a decimal number}$$

Example: IP address 192.53.103.108:

$$((192 * 256 + 53) * 256 + 103) * 256 + 108 = 3224725356$$

NTP server example

NTP-Server `ptbtime1.ptb.de` of the German National Metrology Institute in Braunschweig with the IP address `192.53.103.108`

Replacement NTP server (optional) is NTP server `ptbtime2.ptb.de` of the Physikalisch-Technische Bundesanstalt in Braunschweig with IP address `192.53.103.104`

Condition:

- ⇒ You have OPC UA client.
- ⇒ You know user name and password and have write access.
- ⇒ You know the IP Address of an NTP Server.
- ⇒ You have converted the IP address of this NTP server into a decimal number, as described in chapter "NTP Client Configuration".
- ⇒ Connection to the MVK device has already been established.

Instruction:

- a) In window **Address Space** pen context menu: Root > Objects > **DeviceSet** > **[device name]** > **Configuration** > **NtpClient** > **NtpClientUpdateConfiguration**.

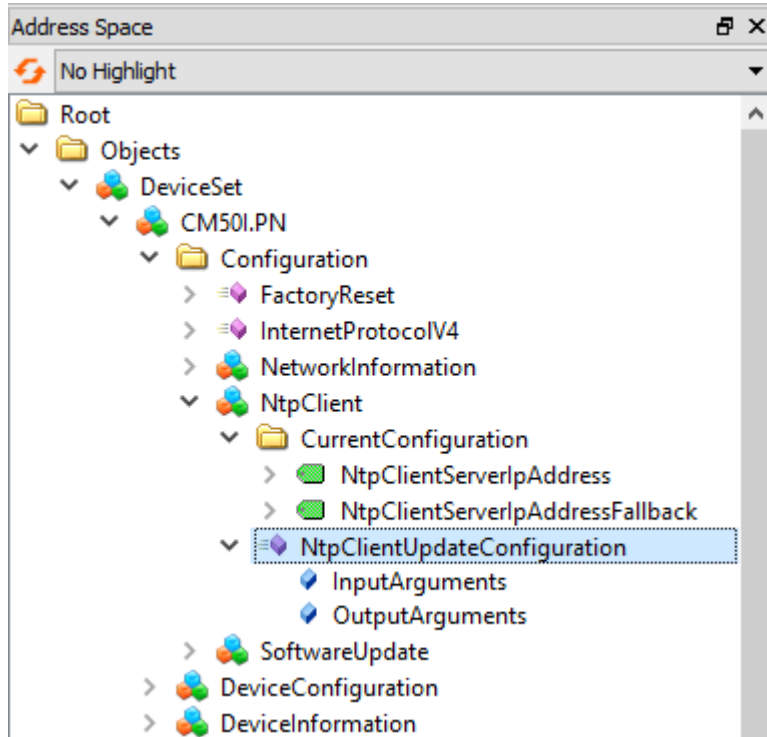

III. 45: NTP client update configuration

- b) In the context menu, select **Call**.

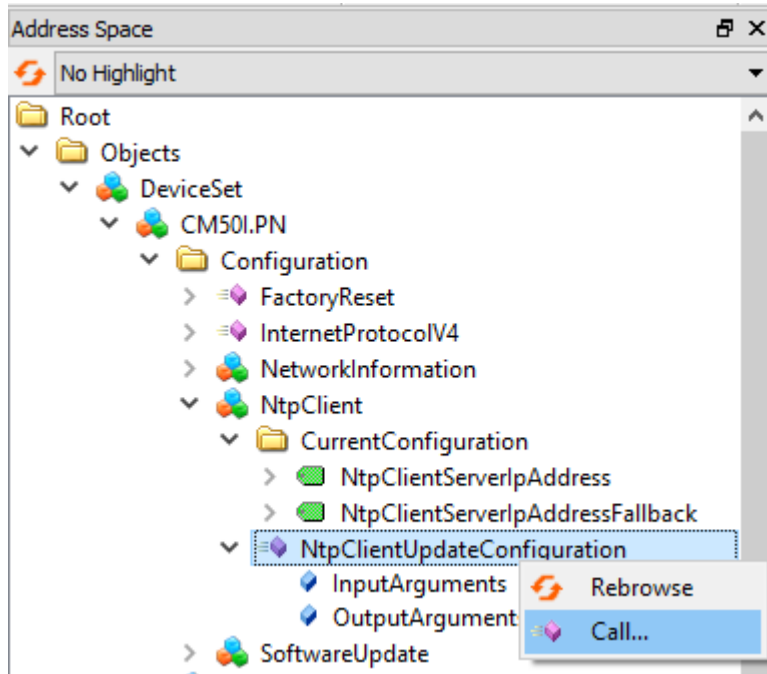

III. 46: NTP client configuration

- ✓ Dialog window **Call NtpClientUpdateConfiguration on NtpClient** pops up:

Input Arguments			
Name	Value	Data Type	Description
ServerIpAddress	3224725356	UInt32	
ServerIpAddressFallback	3224725356	UInt32	

Output Arguments			
Name	Value	Data Type	Description
Status		Int32	

Result			

III. 47: Dialog window for NTP client configuration

- a) In the **Input Arguments** area, enter the value 3224725356 in the input field **ServerIpAddress** for the IP address of the NTP server.
- b) In the **Input Arguments** area, enter 3224725352 in the **ServerIpAddressFallback** input field for the IP address of the replacement NTP server.
- c) Click **Call**.

If the function call was successful, the output field to the right of the status in the **Output Arguments** area displays the value 0 . A green bar with the text *Succeeded* is displayed in the **Result** area.

Both variables *ServerIpAddress* and *ServerIpAddressFallback* are now set. The device receives the current time from the time server via NTP and synchronizes its internal time.

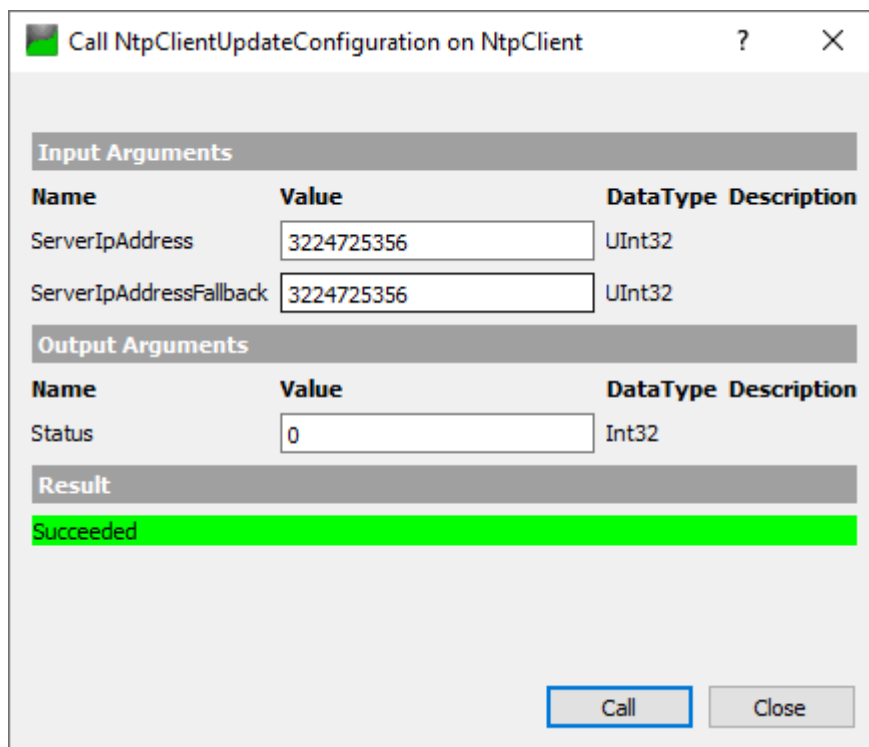

III. 48: Dialog window for NTP client configuration (successful)

10 Operation

10.1 LED indicator

The device provides clearly arranged indicators:

- LED indicator inputs / outputs
- LED indicator EtherCAT
- LED indicator POWER
- EtherCAT diagnostic messages

The front LED indicators are correspondingly marked for clear assignment. Either indicated by continuous or flashing LEDs.

10.1.1 LED assignment to channel and pin

Each input and output is assigned an individual status indicator.

- LED channel 0X (X= port number) is assigned to **pin 4** .
- LED channel 1X (X= port number) is assigned to **pin 2** .

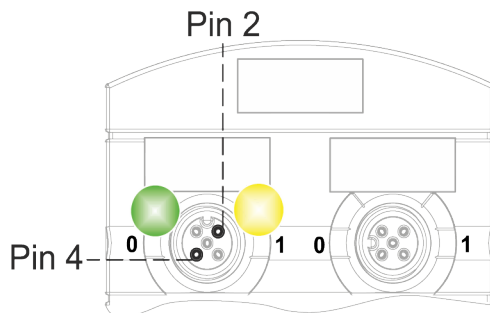

10.1.2 LED flashing behavior

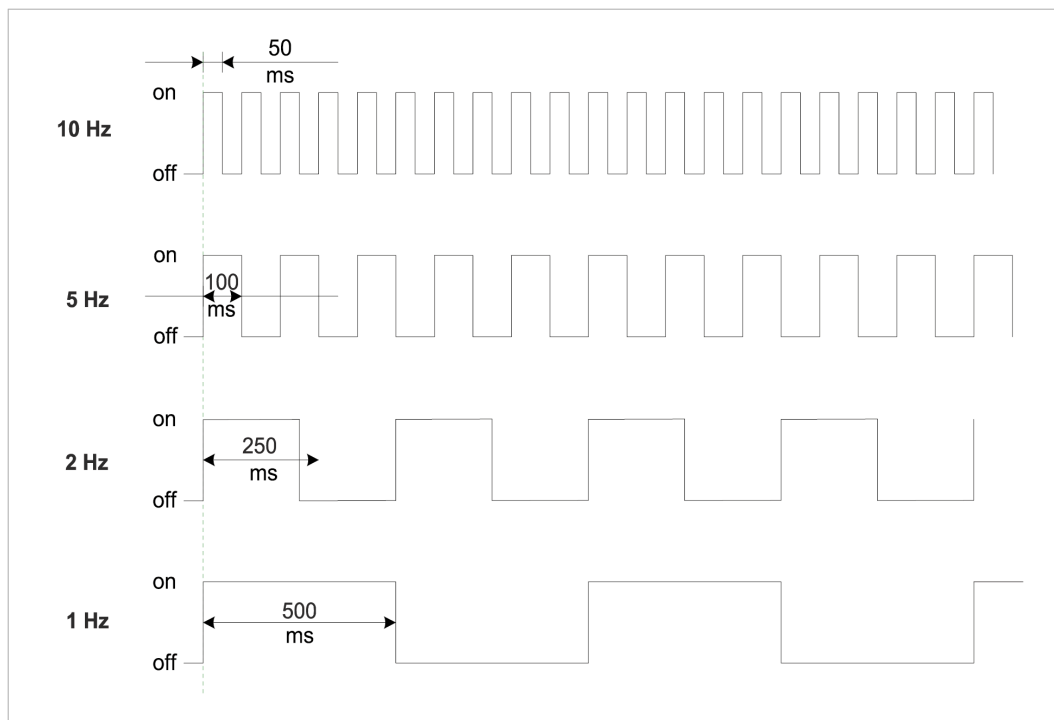



III. 49: LED flashing behavior

10.1.3 LED indicator for inputs and outputs







Each input and output is assigned an individual status indicator.

Pin 2 digital input DI

Indicator	Status	Description
 Yellow	On continuous	Permanent configuration: DI (NO) visible in process data. 24 V
 Red	Flashing at 1 Hz	Overload/short circuit in sensor supply 24 V + Pin1
 Off	Off	Pin 2 is not assigned or disabled

Tab. 21: LED indicator DI pin 2

PIN 2 digital output DO



Indicator	Status	Description
 Yellow	On continuous	Permanent configuration: DO switchable by process data 24 V
 Red	On continuous	Overload / short circuit at pin 2
 Red	Flashing at 1 Hz	Overload/short circuit in sensor supply 24 V + Pin1
 Off	Off	Pin 2 is not assigned or disabled

Tab. 22: LED indicator DO pin 2

Error at the input or output





In the event of error present at one of the inputs or outputs, the related LED at the M12 port will light up red.

Pin 4 digital input DI

Indicator	Status	Description
 Yellow	On continuous	Permanent configuration: DI (NO) visible in process data 24 V
 Red	Flashing at 1 Hz	Overload/short circuit in sensor supply 24 V + Pin1
 Off	Off	Pin 4 is not assigned or disabled







Tab. 23: LED indicator DI pin 4

PIN 4 digital output DO

Indicator	Status	Description
 Yellow	On continuous	Permanent configuration: DO switchable by process data 24 V
 Red	On continuous	Overload / short circuit at pin 4
 Red	Flashing at 1 Hz	Overload/short circuit in sensor supply 24 V + Pin1
 Grey	Off	Pin 4 is not assigned or disabled

Tab. 24: LED indicator DO pin 4

Pin 4 IO-Link mode





Indicator	Status	Description
 Green	On continuous	IO-Link in status <i>Operate</i> .
 Green	Flashing at 1 Hz	<ul style="list-style-type: none"> ▪ Device is not connected ▪ No communication with connected device.
 Green	Flashing at 10 Hz	<ul style="list-style-type: none"> ▪ IO-Link in status <i>Pre-Operate</i> during data storage ▪ Validation failed. Connected IO-Link not compatible.
 Red	On continuous	Overload / short circuit at pin 4
 Red	Flashing at 2 Hz	<ul style="list-style-type: none"> ▪ Validation failed. ▪ Connected IO-Link device for data storage is not compatible. ▪ Data storage failed.
 Grey	Off	IO-Link connection deactivated.

Tab. 25: LED indicator IO-Link mode Pin 4

10.1.4**BUS RUN- and CfgF LED**

- **RUN-LED** indicates the bus status

LED indicator RUN

Indicator	Status	Description
 Green	On continuous	Device in OPERATIONAL mode
 Green	Short flash at long interval (Single flash)	Device in SAFE-OPERATIONAL mode
 Green	Flashing at 2 Hz	Device in PRE-OPERATIONAL mode
 Grey	Off	Device in INIT mode

Tab. 26: LED indicator RUN





LED display Flashing green

Troubleshooting

Instruction:

- ◆ Check the PLC operating status.
 - **ERR-LED** indicates the status of PLC configuration.

ERR LED indicator

Indicator	Status	Description
 Red	Flashing at 2.5 Hz	Configuration error
 Red	Long pause (Single flash)	Slave device application has autonomously changed the EtherCAT status
 Red	Flash-flash pause (Double flash)	Timeout at application watchdog
 Off	Off	Device EtherCAT communication is operational

Tab. 27: ERR LED indicator

LED indicator red

Troubleshooting

- ◆ Check PLC configuration.

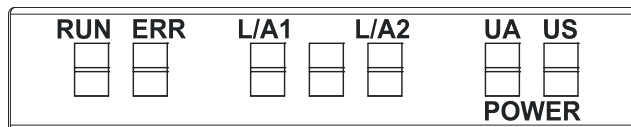

10.1.5

LED indicator L/A1/LA2



- L/A1 and L/A2 (Link/Activity) indicate the EtherCAT communication status at the respective port.

LED indicator L/A1 and L/A2

LED indicator	LED status	Description
 Green	On continuous	Device <ul style="list-style-type: none"> ■ is connected to the EtherCAT network ■ <i>does not</i> transmit/receive EtherCAT frames
 Green	Flashing	Device <ul style="list-style-type: none"> ■ is connected to the EtherCAT network ■ is transmitting/receiving EtherCAT frames
 Off	Off	Device not connected to the EtherCAT network.

Tab. 28: LED indicator L/A1 and L/A2

LED indicator off

Troubleshooting



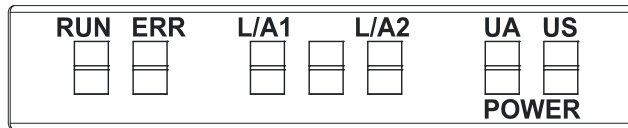

Instruction:

- ◆ Check the line connections.

10.1.6**LED status indicator**

- ST indicates the overall device status.

LED indicator ST

Indicator	Status	Description
 Green	On continuous	Regular FW is running. Error-free operation.
 Green	Flashing at 4 Hz	The process requested by rotary switch position is being executed. Do not switch off device.
 Red	Flashing at 2 Hz	Invalid rotary switch position. System does not start.
 Red	On continuous	Initialization error. Error during device initialization. <ul style="list-style-type: none"> ■ HW issues, ■ no valid configuration, ■ COM FW not found ■ rotary switch operation failed, etc.

Tab. 29: LED indicator ST

LED indicator flashing red

This is what to do:

Instruction:



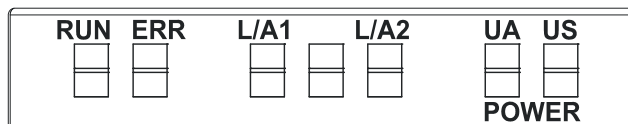

- Select a valid position.
- Restart device.

10.1.7**LED-Anzeige POWER US and UA**

The power LEDs indicate the supply status





- **UA** actuator voltage
- **US** operating voltage

LED indicator POWER US

Indicator	Status	Description
 Green	On continuous	$18\text{ V} \leq \text{US} \leq 30\text{ V}$ error-free operation
 Red	On continuous	$11\text{ V} \leq \text{US} \leq 18\text{ V}$ undervoltage
 Red	Flashing at 4 Hz	$\text{US} > 30\text{ V}$ overvoltage
 Red	Off	$\text{US} < 11\text{ V}$ no voltage

Tab. 30: LED indicator POWER US

LED indicator POWER UA

Indicator	Status	Description
 Green	On continuous	$18\text{ V} \leq \text{UA} \leq 30\text{ V}$ error-free operation
 Red	On continuous	$11\text{ V} \leq \text{UA} \leq 18\text{ V}$ undervoltage
 Red	Flashing at 4 Hz	$\text{UA} > 30\text{ V}$ overvoltage
 Red	Off	$\text{UA} < 11\text{ V}$ no voltage

Tab. 31: LED indicator POWER UA

**INFO**

Fault-free operation is no longer guaranteed at $\text{US} < 18\text{ V}$.

10.2 EtherCAT diagnostic messages

Diagnostics via object $0 \times 10 \text{F}3$ Ring buffer for saving up to 250 diagnostic messages.

All events having triggered device telegrams are logged.

Potential messages

- EtherCAT system diagnostics generated by IO-Link master:
 - Information
 - Warning
 - Error
- IO-Link events transmitted from connected IO-Link device to master.

In addition, each diagnostic message comes with a time stamp [ns] in object $0 \times 10 \text{F}8$ (Time-stamp Object).

Emergency telegrams

Emergency telegrams are messages actively transmitted from the device to the EtherCAT master if a specific event has occurred. This is CoE- based service without acknowledgement.

Device-related diagnostic messages

Error Identifier	EtherCAT Diag Code	EtherCAT Emergency (5 Bytes)	Meaning
0x0100	0xFF00E800	0x0X, 0x00, 0x00, 0x01,0x00	Undervoltage Us
0x0101	0xFF01E800	0x0X, 0x00, 0x00, 0x01,0x01	Overvoltage Us
0x0102	0xFF02E800	0x0X, 0x00, 0x00, 0x01,0x02	Overtemperature
0x0103	0xFF03E800	0x0X, 0x00, 0x00, 0x01,0x03	Overload at Us
0x0104	0xFF04E800	0x0X, 0x00, 0x00, 0x01,0x04	Overload at Ua
0x0105	0xFF05E800	0x0X, 0x00, 0x00, 0x01,0x05	Undertemperature
0x0106	0xFF06E800	0x0X, 0x00, 0x00, 0x01,0x06	Undervoltage Ua
0x0107	0xFF07E800	0x0X, 0x00, 0x00, 0x01,0x07	Overvoltage Ua
0x0108	0xFF08E800	0x0X, 0x00, 0x00, 0x01,0x08	Force mode active

Tab. 32: Device-related diagnostic messages



INFO

EtherCAT Telegram: First byte:

- a) 0x00 for diagnostics occurred *and*
- b) 0x01 for disappearing diagnostics.

Port-related diagnostic messages

Error Identifier	EtherCAT Diag Code	EtherCAT Emergency (5 Bytes)		Meaning
0x1800	0x0001E002	0xE0, 0x02, 0xXX, 0x18, 0x00	0x002C	No device (communication)
0x1801		0xE0, 0x02, 0xXX, 0x18, 0x01	0x0001	Startup parametrization error
0x1802		0xE0 0x02, 0xXX, 0x18, 0x02	0x0002	Incorrect Vendor ID
0x1803		0xE0, 0x02, 0xXX, 0x18, 0x03	0x0003	Incorrect DeviceID
0x1804		0xE0, 0x02, 0xXX, 0x18, 0x04	0x0004	Short circuit at pin 4 (IOL)
0x1805		0xE0, 0x02, 0xXX, 0x18, 0x05	0x0005	Overtemperature
0x1806		0xE0, 0x02, 0xXX, 0x18, 0x06	0x0006	Short circuit at pin 1
0x1807		0xE0, 0x02, 0xXX, 0x18, 0x07	0x0007	Overcurrent at pin 1
0x1808		0xE0, 0x02, 0xXX, 0x18, 0x08	0x0008	Device Event overflow
0x1809		0xE0, 0x02, 0xXX, 0x18, 0x09	0x0009	Backup inconsistency – memory out of range
0x180A		0xE0, 0x02, 0xXX, 0x18, 0x0A	0x000A	Backup inconsistency – identity fault
0x180B		0xE0, 0x02, 0xXX, 0x18, 0x0B	0x000B	Backup inconsistency – Data storage error
0x180C		0xE0, 0x02, 0xXX, 0x18, 0x0C	0x000C	Backup inconsistency – upload fault
0x180D		0xE0, 0x02, 0xXX, 0x18, 0x0D	0x000D	Backup inconsistency – download fault
0x180E		0xE0, 0x02, 0xXX, 0x18, 0x0E	0x000E	Class B power (pin 2) missing or undervoltage

Error Identifier	EtherCAT Diag Code	EtherCAT Emergency (5 Bytes)		Meaning
0x180F		0xE0, 0x02, 0xFF, 0x18, 0x0F	0x000F	Class B power (pin 2) short circuit
0x1810		0xE0, 0x02, 0xFF, 0x18, 0x10	0x0010	Short circuit at pin 2
0x1811		0xE0, 0x02, 0xFF, 0x18, 0x11	0x0011	Short circuit at pin 4 (digital out)
0x1812		0xE0, 0x02, 0xFF, 0x18, 0x12	0x0012	Overcurrent at pin 2
0x1813		0xE0, 0x02, 0xFF, 0x18, 0x13	0x0013	Overcurrent at pin 4 (digital out)
0x6000		0xE0, 0x02, 0xFF, 0x60, 0x00	0x0014	Invalid cycle time
0x6001		0xE0, 0x02, 0xFF, 0x60, 0x01	0x0015	Revision fault – incompatible protocol version
0x6002		0xE0, 0x02, 0xFF, 0x60, 0x02	0x0016	ISDU batch failed
0xFF26		0xE0, 0x02, 0xFF, 0xFF, 0x26	0x0017	Port status changed – Use "SMI_PortStatus" service for port status in detail
0xFF27		0xE0, 0x02, 0xFF, 0xFF, 0x27	0x0018	Data Storage upload completed and new data object available
0xFF31		0xE0, 0x02, 0xFF, 0xFF, 0x31	0x0019	DL: Incorrect Event signalling

Tab. 33: Port-related diagnostic messages

**INFO**

EtherCAT Telegram: First byte:

- a) 0xE002 + port number + error code for the occurred diagnostics,
- b) 0x0000 + port number + error code for disappearing diagnostics.

11 Web server

The web server is a graphical tool with which you can obtain information about the device quickly and intuitively.

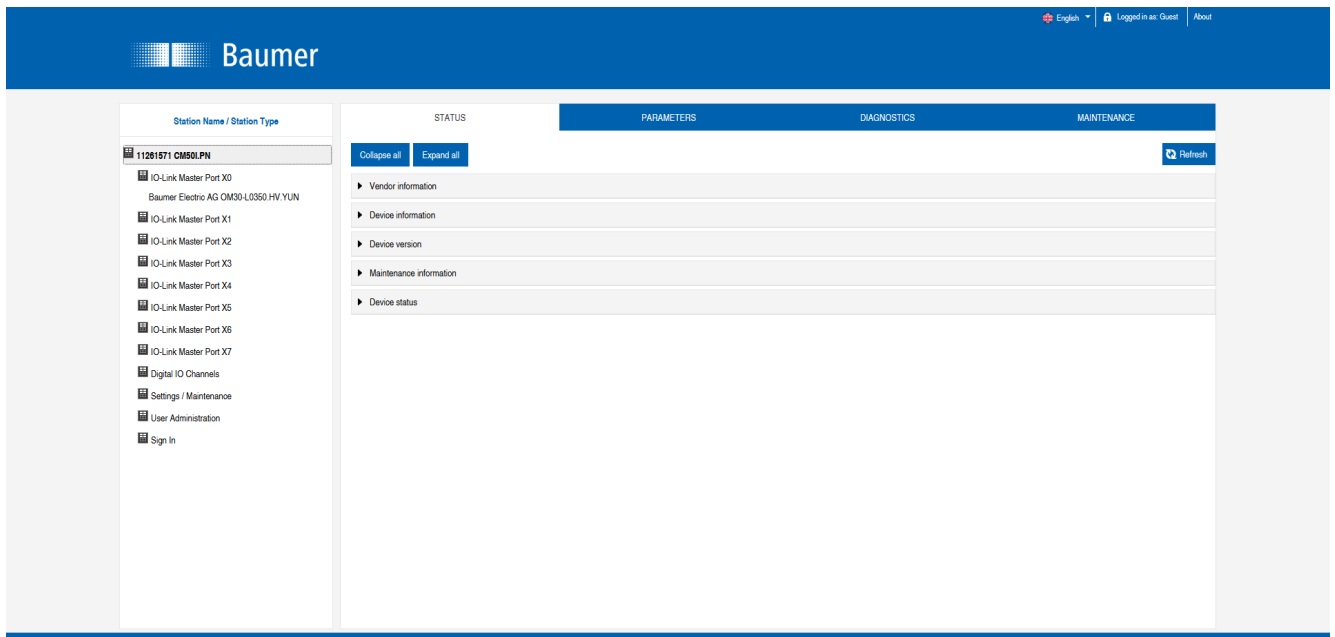

III. 50: Web server



INFO

The devices shown in the screenshots serve as examples.

11.1 Starting the web server

Condition:

⇒ The current versions of the following browsers with HTML5 and ES5 are supported: *Mozilla Firefox, Microsoft Edge, Google Chrome.*

Instruction:

- a) Start the web browser.
- b) Enter the device IP address in the web browser.

Result:

- ✓ The start screen of the web server is the **Status** page.

11.2 Access and login

Username and password

Instruction:

- ◆ Enter the login data for user name and password at the first start:
 - User name <admin>
 - Password <private>

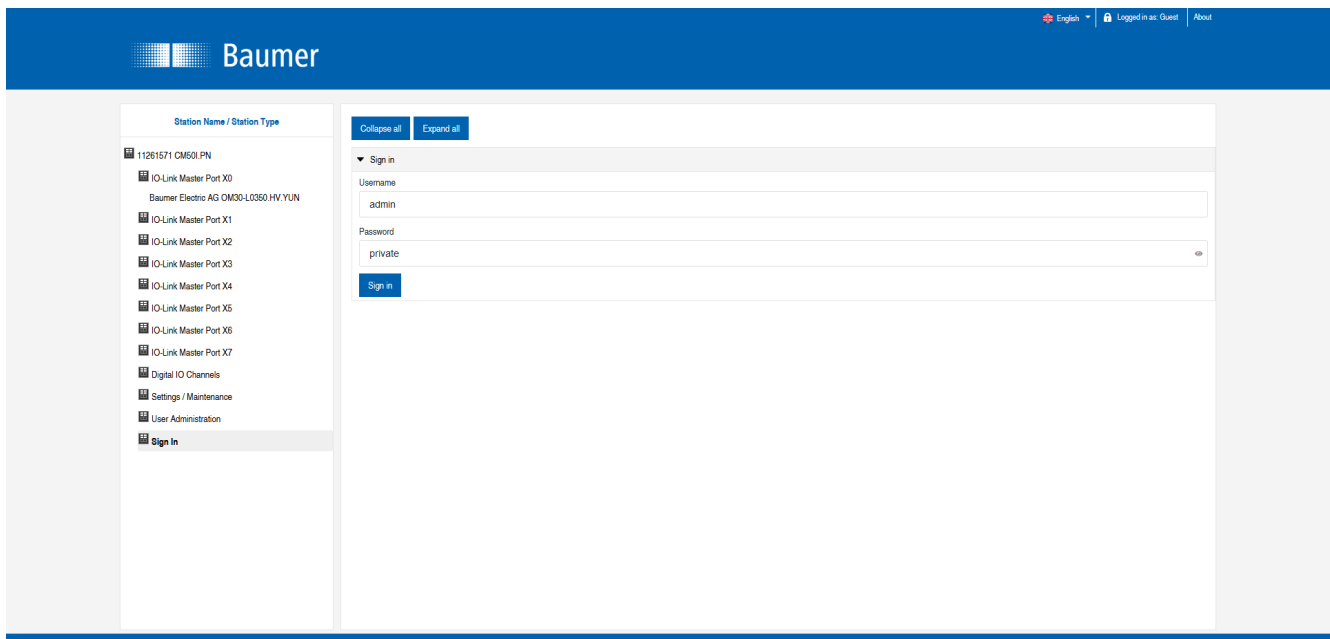

Change password

NOTICE

Ensure data security!

- a) Change username and password after first login and after every restore default.

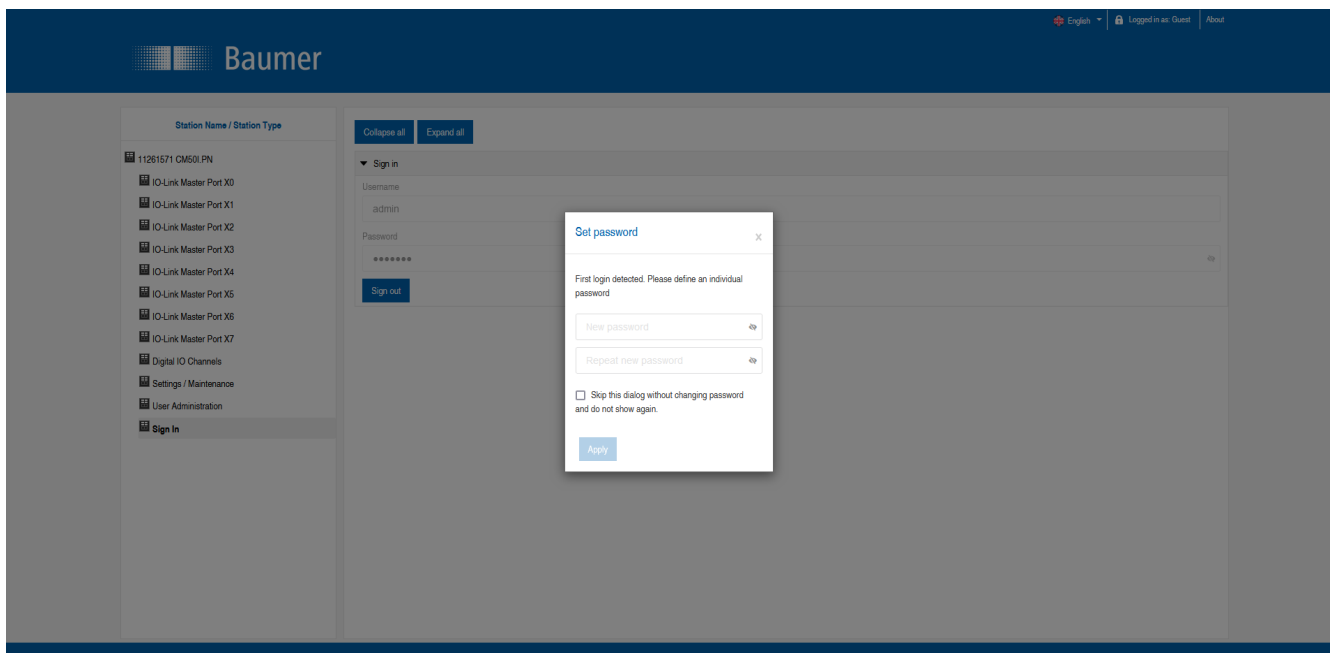

11.3 Initial screen

Operating areas

The web server provides 4 operating areas.

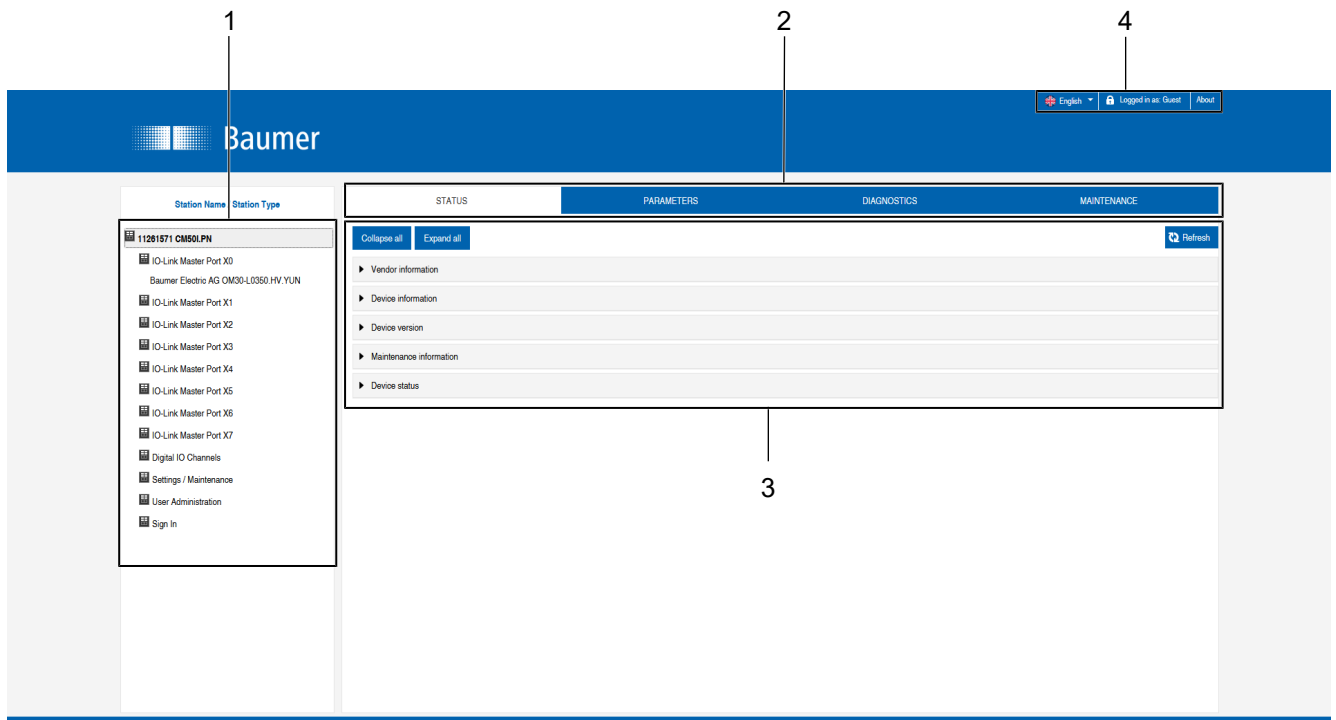

III. 51: Operating areas

1	System tree	Provides device and available sub functions.
2	Menu bar	The menu bar can be used to switch between the different pages of the device or the sub-function. In addition, the white highlighting indicates the page you are currently on.
3	Page content	This area displays the content of the selected page.
4	Header bar	Language and interface settings, system information.

11.4 Menu bar

The first line in the system tree provides device with article number and product name.

The menu bar comprises the following menu items:

- **Status**
- **Parameter**
- **Diagnostic tools**
- **Preventive maintenance**

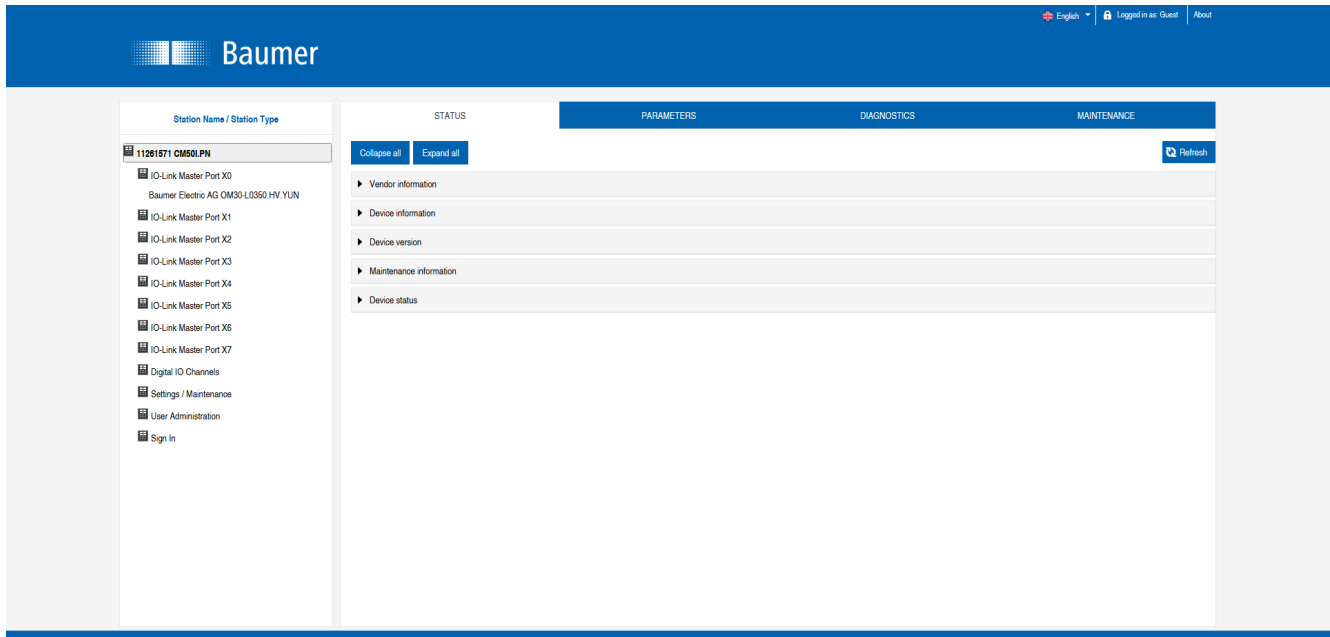

III. 52: Menu bar

11.4.1 STATUS menu

The **Status** menu item contains the following sub-items:

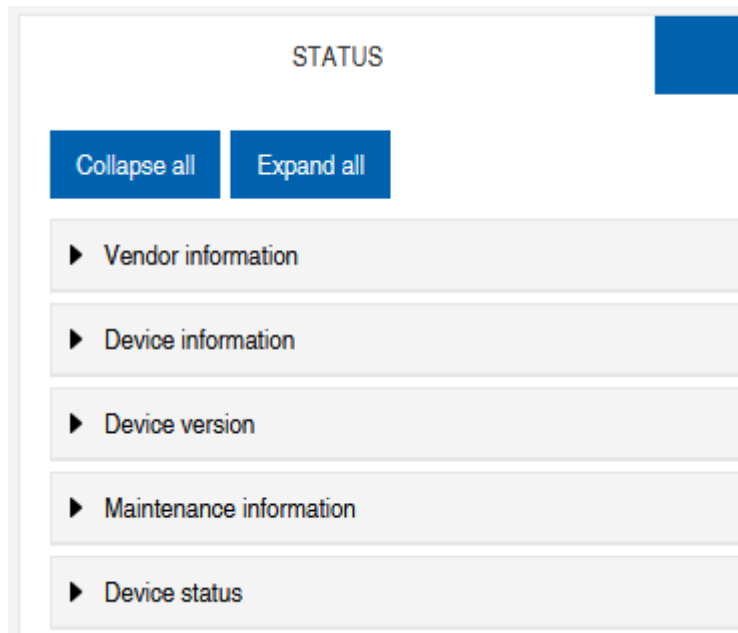

III. 53: **Status** menu item

Manufacturer information

Manufacturer information displays the following information:

Parameter designation	Description
Manufacturer name	Fixed data from the manufacturer
Manufacturer address	Fixed data from the manufacturer
Manufacturer telephone	Fixed data from the manufacturer
Manufacturer URL	Website of the manufacturer

Device information

Device information displays the following information:

Parameter designation	Description
Order number	Article number of the device
Hardware name	Permanent article number of the device
Software name	Fieldbus designation of the device
Software number	Device manufacturing number

Device version

Device version displays the following information:

Parameter designation	Description
Hardware version	Hardware execution version
Software version	Software version run in the device
Website version	Web server version currently run in the device

Maintenance information



INFO

Maintenance information is read only. The fields are entered or changed via **Settings/Maintenance | Maintenance information**.

Maintenance information provides the following information:

Parameter designation	Description
Name	Device name, free text
Installation location	Name of place, free text
Contact information	Contact, free text
Description	Description, free text
Last maintenance date (yyyy-mm-dd)	Free date entry
Next maintenance date (yyyy-mm-dd)	Free date entry

IO-Link device information

IO-Link device information displays the following information:

Parameter designation	Description
1L Voltage [V]	Provides sensor voltage in volts
1L Current [A]	Provides sensor voltage in amperes
2L Voltage [V]	Provides actuator voltage in volts
2L Current [A]	Provides actuator voltage in amperes
Temperature [°C]	Display of the appliance temperature in Celsius
Total operating time [hh:mm:ss]	Operating time since the device was switched on
Number of starts	Number of restarts

11.4.2 Menu PARAMETERS

The **Parameters** menu item contains the following sub-items:

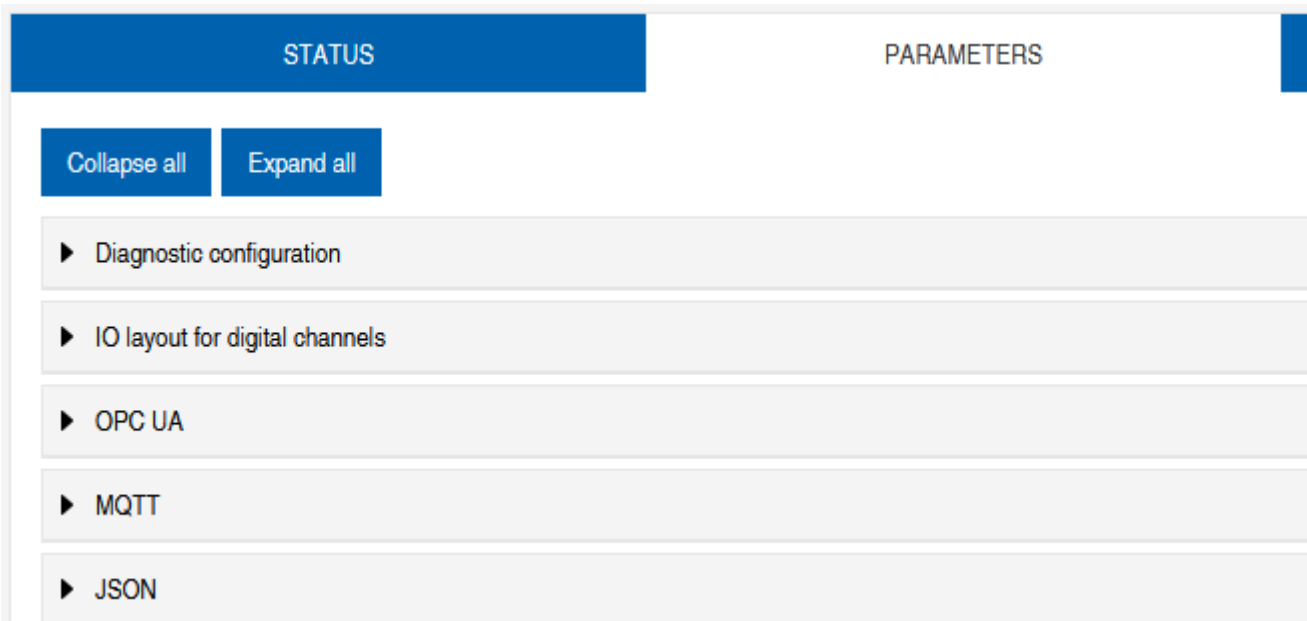

III. 54: **Parameter** menu

OPC UA

Users with admin and operator rights can change settings and enter the OPC UA port number. Guest users with read rights only.

OPC UA displays the following information:

Parameter designation	Description
Activate OPC UA Server	OPC UA server on the module active / passive
Allow OPC UA clients to write ISDU data	OPC UA client may write ISDU data (Indexed Service Data Unit) to the module on the IO-Link master
Allow OPC UA clients to write PDO data	OPC UA client may write PDO (process data objects) to the module on the IO-Link master
OPC UA port number	Display / definition of the OPC UA port

MQTT

Users with admin and operator rights can change settings and enter the IP address of the MQTT server. Guest users with read rights only.

MQTT displays the following information:

Parameter designation	Description
Enable MQTT	MQTT client on component active / passive
MQTT server IP address	MQTT server IP address
MQTT Client ID	Read/write MQTT client ID
Client head topic	Read/write MQTT topic
Topic for system data	Read/write MQTT topic

JSON

Users with admin and operator rights can activate and deactivate JSON. Guest users with read rights only.

JSON displays the following information:

Parameter designation	Description
Enable JSON	JSON interface on component active / passive

11.4.3 DIAGNOSTICS menu

The incoming and outgoing alarms of the master are displayed in the **Diagnostics** menu item.

The menu shows an overview of the diagnostic messages.

Depending on the setting in the **Please select an entry** drop-down menu, the following device diagnostics are displayed:

- **Enabled**
 - All pending diagnostics at the time of the web server call.
 - All diagnoses that no longer exist are not displayed.
- **History**
 - All diagnostics from the retentive diagnostics memory that no longer exist are displayed.
 - More than 40 diagnostics in the memory. The latest diagnostics overwrites the most previous one in the memory.

III. 55: **Diagnostics** menu item

11.4.4 MAINTENANCE menu

In the **Maintenance** menu item, users with admin and operator rights can delete the diagnostic memory.

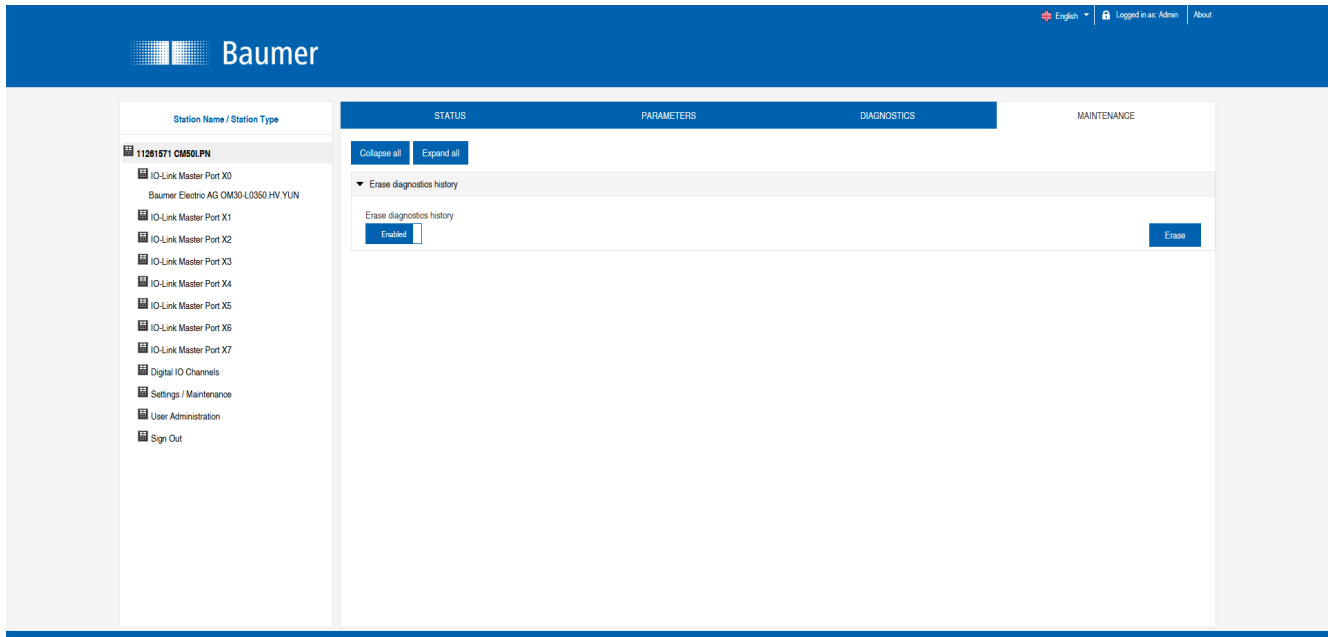

III. 56: Delete diagnostic memory

11.5 IO-Link master port

The system tree provides 8 IO-Link master ports (X0 ... X7) for individual selection. According to the user role, information is read only or enables configuration.

In active IO-Link communication, the IO-Link device name automatically appears under the relevant port.

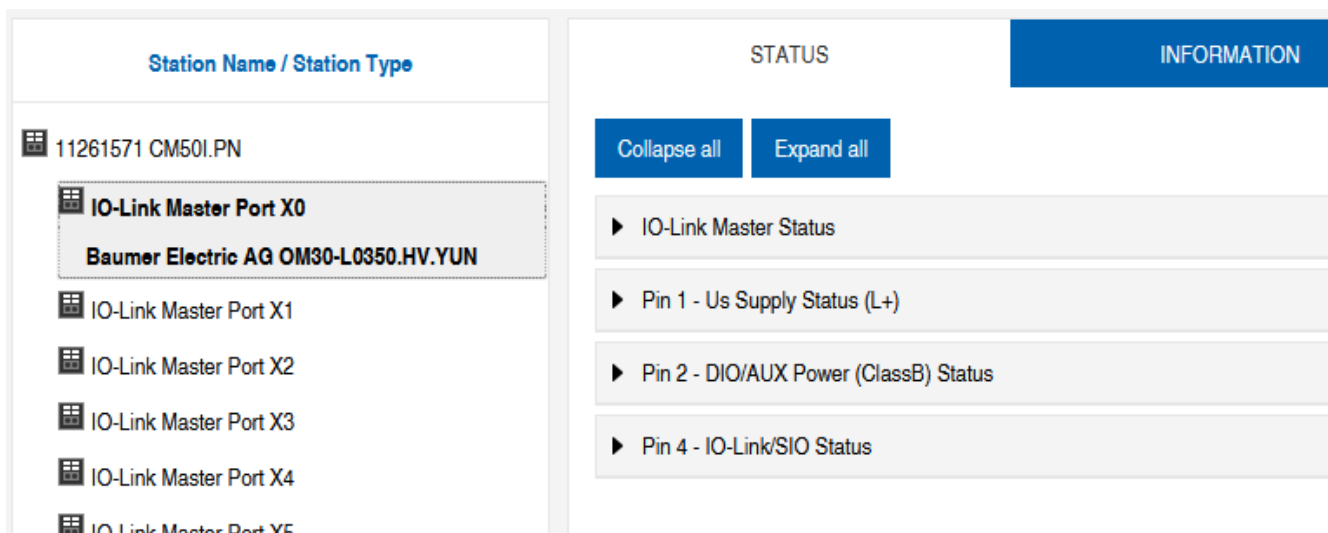

III. 57: IO-Link master port

11.5.1 STATUS menu

The IO-Link master status is displayed here in the **Status** menu.

STATUS		INFORMATION	CONFIGURATION
Collapse all		Expand all	
▼ IO-Link Master Status			
- State	Operate		
- Quality	0x2		
- Revision ID	0x11		
- Baudrate	230.4 kbps		
- Cycle time	1.0 ms		
- Input data length	6		
- Output data length	1		
- Vendor ID	0x15E		
- Device ID	0x25F		

/// 58: IO-Link master port - IO-Link master status

If pin 4 is in IO-Link mode, all relevant IO-Link data including the I/O bytes of the device are displayed.

If pin 4 is in operation without a connected IO-Link device, it is displayed that no device is connected.

▼ IO-Link Master Status	
- Port function	Digital input

/// 59: IO-Link master port - IO-Link master status for digital operation

If pin 4 is configured as a digital input, you can see it here.

Optional indication of:

- Status: Disabled
- Status: Digital input
- Status: Digital output

Port Status - Pin 1

Port status - pin 1 provides the following information

Parameter designation	Description
Temperature [°C]	Temperature in degrees Celsius
Voltage [V]	Voltage in Volts
Current [A]	Current in Ampere
Status	Pin status

Port Status - Pin 2

Port status - pin 2 provides the following information

Parameter designation	Description
Temperature [°C]	Temperature in degrees Celsius
Voltage [V]	Voltage in Volts
Current [A]	Current in Ampere
Status	Pin status

Port Status - Pin 4

Port status - pin 4 provides the following information

Parameter designation	Description
Temperature [°C]	Temperature in degrees Celsius
Voltage [V]	Voltage in Volts
Current [A]	Current in Ampere
Status	Pin status

11.5.2 INFORMATION menu

Menu item **Information** provides the following subitems:

STATUS	INFORMATION	CONFIGURATION	IO-LINK PARAM
Collapse all Expand all			
▼ IO-Link Device Information			
- Min cycle time	1.0 ms		
- Function ID	0		
- Number of profile IDs	1		
- Vendor name	Baumer Electric AG		
- Vendor text	www.baumer.com		
- Product name	OM30-L0350.HV.YUN		
- Product ID	11232075		
- Product text	Optical distance sensor, Connector M8		
- Serial number	R245.85343		
- Hardware revision	01.00.01		
- Firmware revision	01.01.09		

III. 60: IO-Link Master Port – **Information**

IO-Link device information

Technical data and manufacturer information of a connected and active IO-Link device is provided at the related master port.

“IO-Link device information” provides the following information:

Parameter designation	Description
Minimum. cycle time	Minimum process cycle time of IO-Link device
Function ID	Function ID IO-Link device
Number of profile IDs	Number of profiles supported by the IO-Link device
Manufacturer name	Manufacturer name IO-Link device

Parameter designation	Description
Manufacturer text	Manufacturer text IO-Link device
Product name	Product name IO-Link device
Product ID	Article number IO-Link device
Product text	Additional description IO-Link device
Serial number	Serial number
Hardware version	Hardware version
Firmware version	Firmware version

11.5.3 CONFIGURATION menu

Menu item **Configuration** of the selected IO-Link port provides the setting of pin 1, pin 2 and pin 4 and allows also for configuration.

Users with operator and admin rights can set the functions and behavior of pin 1, pin 2 and pin 4.

Users with service and maintenance rights have read rights.

Pin 4 can be deactivated or configured as an IO-Link master, input or output.

III. 61: IO-Link master port - configuration (pin 4)

Pin 2 can be deactivated or configured as an input, output or DIO in **Automatic Mode**.

III. 62: IO-Link master port - Configuration - IQ behavior (pin 2)

If pin 2 or pin 4 is configured as an input, the digital input filters can be set individually.

The screenshot shows the 'IO-LINK PARAMETERS' tab in a web interface. Under the 'Port Functions - Pin 2' section, there are three rows of configuration options:

- Port function:** Set to 'Automatic mode (DIO)'.
- Digital input signal filter:** Set to 'No digital input filter'.
- Output current limitation for DIO:** A dropdown menu is open, showing options: 'No digital input filter', '1ms', '3ms' (highlighted), '5ms', '10ms', and '15ms'.

Other sections visible include 'Port Functions - Pin 4', 'Port Functions - Pin 1', and 'Port Diagnostics'. Buttons for 'Collapse all', 'Expand all', 'Save', and 'Refresh' are present at the top.

III. 63: IO-Link master port - Configuration - Setting digital input filters

11.5.4 IO-LINK PARAMETERS menu

In this menu item, the *ISDU (Index Service Data Unit)* of the device can be read and written during IO-Link operation. This primarily allows an IO-Link device to be evaluated or parameterized without a controller. The input can be made in both hex and ASCII format.



INFO

Observe the information in the IO-Link device manufacturer's manual.

Users with maintenance and admin rights can write ISDU values. Users with service rights have read rights.

The screenshot shows the 'IO-LINK PARAMETERS' tab with the 'ISDU Communication' section expanded. It contains the following fields:

- Index:** Input field with value '00'.
- Subindex:** Input field with value '00'.
- Input data:** Input field with value '00'.
- Format:** Dropdown menu set to 'Hex'.

Below the fields are 'Read' and 'Write' buttons. A note states: '*All values are in hexadecimal without spaces.' A 'Clear history' button is located at the bottom left.

III. 64: IO-Link master port - IO-LINK PARAMETER

11.5.5 PROCESS DATA menu

In the **Process data** menu item, the current process data of the connected IO-Link device is continuously displayed if pin 4 of the corresponding port has been configured as an IOL port. Example: Port X2: Pin 4 (IO- Link Autostart) and Pin 2 (Digital output static on).

STATUS	INFORMATION	CONFIGURATION	IO-LINK PARAMETERS	PROCESS DATA
Collapse all Expand all				
▼ Process Data				
Pin 4 IOL Input				00,01,0f,42,fa,01
Pin 4 IOL Output				00
Force Pin 4 IOL Output Data			Write Disable Forcing	0
Pin 2 DO				0
Pin 2 DI				0
Format				Hexadecimal

/// 65: IO-Link Master Port - PROCESS DATA

The current statuses of the digital inputs are displayed in this menu item. Example: Port X1: Pin 4 (DI) and pin 2 (DI)

STATUS	CONFIGURATION	PROCESS DATA
Collapse all Expand all		
▼ Process Data		
Pin 4 DI		0
Pin 2 DO		0
Pin 2 DI		0
Format		Hexadecimal

/// 66: IO-Link master port - Digital inputs - PROCESS DATA

11.6 Digital IO channels/ IO overview

In the **Configuration** menu of the selected IO-Link port, the setting of pin 2 and pin 4 on the selected port is displayed. Outputs can be set under certain conditions.

11.6.1 Input data

Each user can monitor the digital statuses of the inputs configured on the device.



III. 67: Overview of input data

11.6.2 Output data

Allow outputs to be set

Users with admin, service and maintenance rights can allow the outputs to be set in this menu.

The right to do this is only granted if the device is not in an active fieldbus connection with the control unit. The control system has priority.

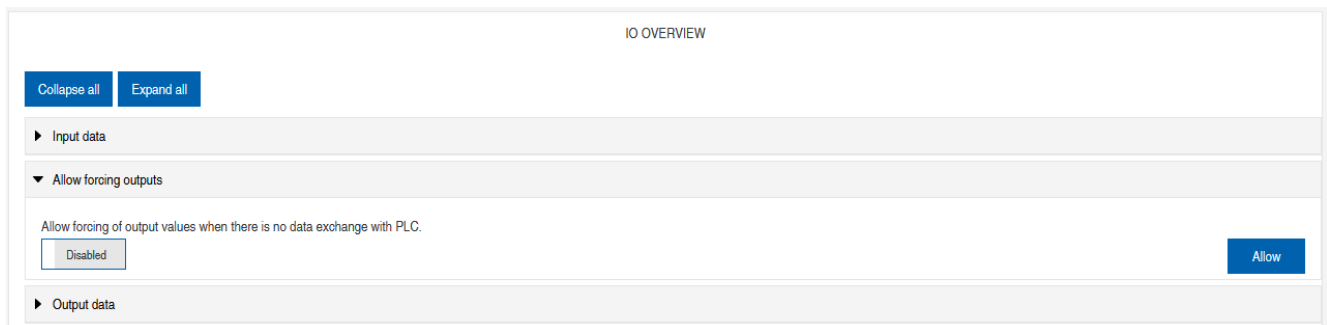

III. 68: Allow outputs to be set

Setting output data

Guest users are not permitted to set the exits.

All other users (admin, operator, maintenance) can set the outputs.

As soon as the user (admin, operator, maintenance) logs out, the outputs go to 0.

As soon as a fieldbus is actively working with the device, the outputs go to 0 and then adopt the status that they receive from the controller.

IO OVERVIEW

[Collapse all](#) [Expand all](#)

▶ Input data

▼ Allow forcing outputs

Allow forcing of output values when there is no data exchange with PLC.

Enabled [Allow](#)

▼ Output data

Port X0 Pin 4 (Channel 00)	<input checked="" type="checkbox"/> Enabled
Port X1 Pin 4 (Channel 01)	<input checked="" type="checkbox"/> Enabled
Port X2 Pin 4 (Channel 02)	<input type="checkbox"/> Disabled
Port X3 Pin 4 (Channel 03)	<input type="checkbox"/> Disabled
Port X4 Pin 4 (Channel 04)	<input type="checkbox"/> Disabled
Port X5 Pin 4 (Channel 05)	<input type="checkbox"/> Disabled
Port X6 Pin 4 (Channel 06)	<input type="checkbox"/> Disabled
Port X7 Pin 4 (Channel 07)	<input type="checkbox"/> Disabled
Port X0 Pin 2 (Channel 10)	<input type="checkbox"/> Disabled

/// 69: Setting output data

11.7 Settings and maintenance

11.7.1 DEVICE CONFIGURATION menu

In Profinet, the address is usually assigned by the controller using DCP. Only the IP setting can therefore be read in the web server.

English Logged in as: Admin About

Baumer

Station Name / Station Type

- 11261571 CM501.PN
 - IO-Link Master Port X0
 - Baumer Electric AG OM30-L0350.HV.YUN
 - IO-Link Master Port X1
 - IO-Link Master Port X2
 - IO-Link Master Port X3
 - IO-Link Master Port X4
 - IO-Link Master Port X5
 - IO-Link Master Port X6
 - IO-Link Master Port X7
 - Digital IO Channels
 - Settings / Maintenance**
 - User Administration
 - Sign Out

DEVICE CONFIGURATION MAINTENANCE INFORMATION FIRMWARE FACTORY RESET

[Collapse all](#) [Expand all](#) [Refresh](#)

▼ Interface configuration status

Device IP address	<input type="text" value="192.168.0.250"/>
Subnet mask	<input type="text" value="255.255.255.0"/>
Gateway IP address	<input type="text" value="0.0.0.0"/>

192.168.0.250/files/index.htm#/io-linkmaster-port-x6

/// 70: Settings IP address Profinet

11.7.2 MAINTENANCE INFORMATION menu

Users with service, maintenance and admin rights can enter information about the device here.

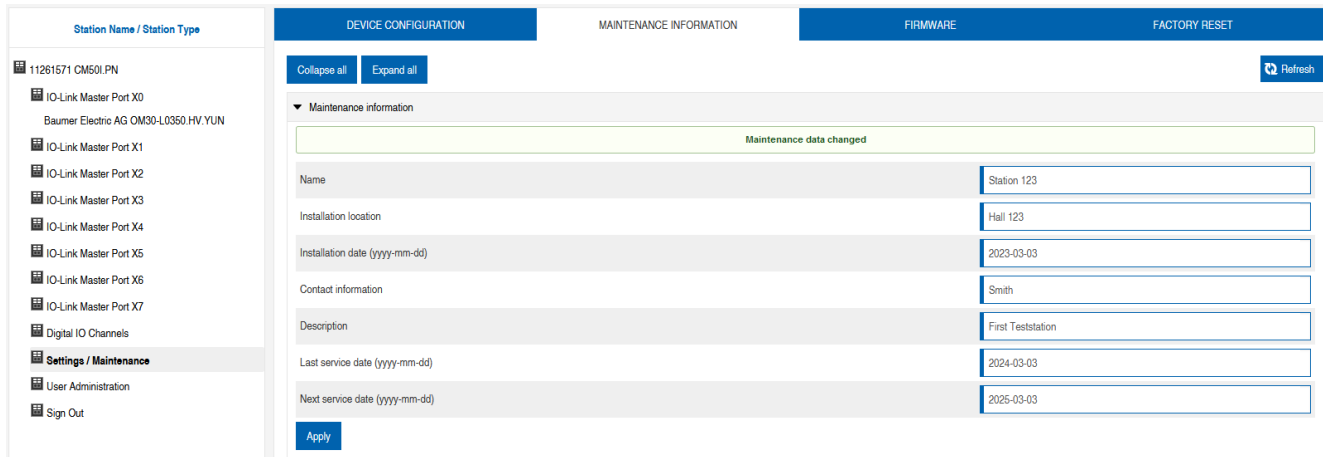

III. 71: Maintenance information setting

The maintenance information appears in the device in the **Status** menu item and **Maintenance information** submenu.

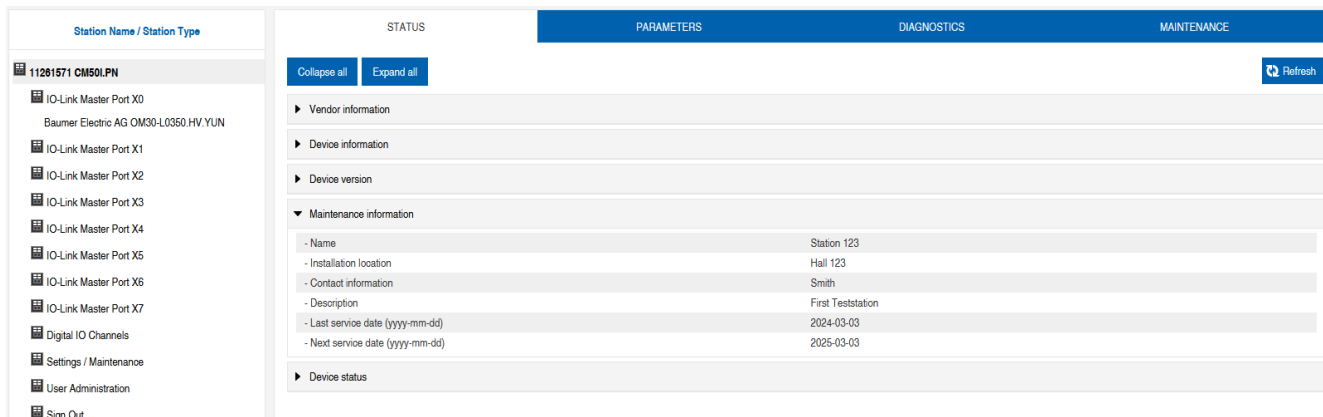

III. 72: Maintenance information status

11.7.3 FIRMWARE menu

This menu item displays the data of the firmware running on the device.

Users with service, maintenance and admin rights can upload new firmware, provided in ZIP folders, to the device here. After successful loading, the device checks the firmware container and starts automatically with the new firmware version.

The screenshot displays the Baumer web interface. The top navigation bar includes the Baumer logo, a language dropdown set to 'English', and a user status indicator 'Logged in as Admin' with an 'About' link. The main interface is divided into several tabs: 'DEVICE CONFIGURATION', 'MAINTENANCE INFORMATION', 'FIRMWARE', and 'FACTORY RESET'. The 'FIRMWARE' tab is active, showing a 'Collapse all' and 'Expand all' control. Under 'Details of current active firmware', the following information is displayed:

- Hardware name	CM50I.PN
- Software version	V1.3.0
- Kernel version	V1.2.0.20
- Webpage version	2.0.0-V

Below this, the 'Firmware update' section contains a file input field with a dropdown arrow and an 'Update' button.

III. 73: Firmware

11.7.4 WORK RESET menu

In this menu item, users with service, maintenance and admin rights can reset the entire device or individual sub-areas (device information, network, application).

The screenshot displays the Baumer web interface with the 'FACTORY RESET' tab active. The 'Factory reset' section contains the following options:

- Delete stored device information e.g. Device Maintenance Information, NTP settings, OPC UA IO-Link Master specific tags, etc.
- Delete stored network adapter settings e.g. Communication and IP Address Configuration, Name Of Station, etc.
- Delete stored application parameters e.g., Port Configuration and Parameters, IO-Link Data Storage, etc.
- Delete all stored settings

At the bottom of this section are 'Delete settings' and 'Restart' buttons.

III. 74: Factory reset

11.8 User administration

User administration can only be carried out with admin rights.

Default at delivery uses `admin` as administrator with password `private`.



INFO

In the system with running fieldbus, the administrator default password can be edited at the control unit.

Users log in and off in the system tree at the bottom left.

- ◆ Click on **Logout**.

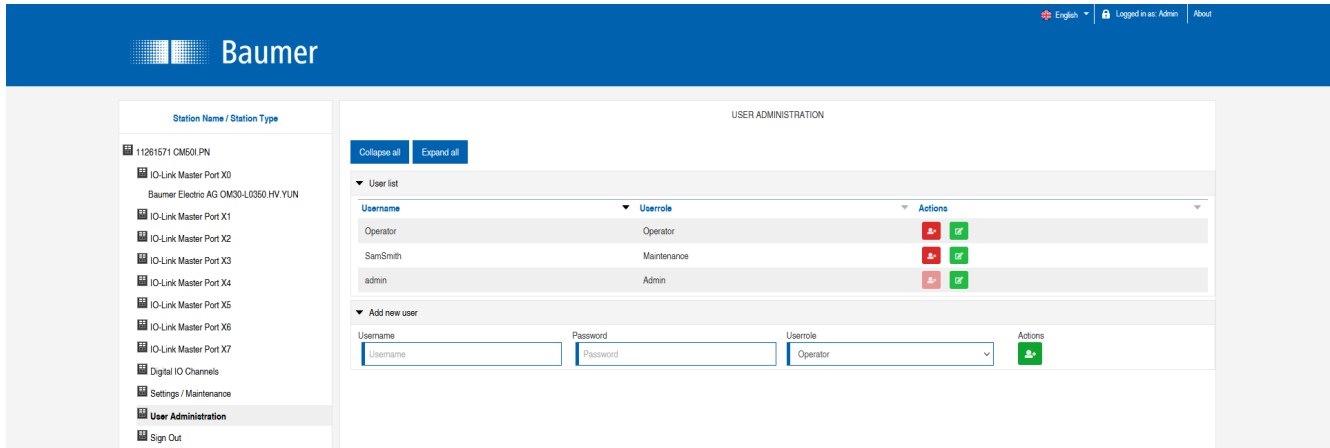

III. 75: User administration

12 Maintenance and cleaning

⚠ WARNING**Material damage due to defective or damaged appliances.**

The function of the devices is not guaranteed.

- a) Replace defective or damaged devices.
-

**INFO**

You can replace the device with the same type if maintenance is required.

- a) Check whether the switch settings of the old and new device are identical.
-

**INFO**

Cleaning the appliance.

- a) Only use oil-free compressed air or spirit.
 - b) Only use non-fibrous materials (e.g. leather cloth).
 - c) Do not use contact spray.
-

13 Annex

13.1 Accessories

13.1.1 Tools

Designation	Art. no.
M12 installation wrench set SW 13	11238694
M12 mounting wrench bit SW 17	11238695



III. 76: Assembly wrench



INFO PRODUCTS AND ACCESSORIES

You will encounter a large product selection at: <https://www.baumer.com>

13.2

Glossary

Term	Significance
AoE	ADS over EtherCAT
Bus-Run-LED	LED for signaling the bus status.
CfgF-LED	LED for signaling correct/incorrect configuration.
Byte	iTerm from IEC 61158. Corresponds to 1 byte or 8 bits.
DHCP	Dynamic Host Configuration Protocol DHCP enables dynamic server distribution of IP address and configuration information to clients. As a rule, the DHCP server provides the client with at least this basic information: <ul style="list-style-type: none"> ▪ IP address ▪ Subnet mask ▪ Standard gateway
CIP	Common Industrial Protocol Common Industrial Protocol is an application protocol of automation technology. It supports fieldbus transition into networks of industrial Ethernet and IP. This industrial protocol utilizes EtherNet/IP in the application layer as interface between fieldbus and control unit, I/O, etc.

Term	Significance
CoE	CANopen over EtherCAT
DI	Digital Input
DIP switch	Dual in-line package/switch with two parallel rows of connections.
DO	Digital output/digital output
EDS	Electronic Data Sheet (electronic data sheet) EDS files are external files with device information. EDS files provide the necessary information for device parameter access to change configuration.
EMCY	Emergency messaging
EMC	Electromagnetic compatibility
EN	European standard
EoE	Ethernet over EtherCAT
ESD	Electrostatic discharges
ESI-File	Device description (EtherCAT-Slave-Information) in the form of an XML file provided by the manufacturer.
ESM	The EtherCAT slaves status control is via EtherCAT-State-Machine. According to the status, several functions can be accessed or executed in the EtherCAT slave. Particularly during slave start-up, different stages require transmission of specific commands by the EtherCAT master.
ETG	EtherCAT Technology Group ETG is the world's largest international user and manufacturer association for Industrial Ethernet.
EtherCAT	Ethernet for Controller and Automation Technology EtherCAT was originally developed by the company Beckhoff Automation GmbH and is now supported and further developed by EtherCAT Technology Group (ETG).
EtherCAT-Master	The EtherCAT master is the I/O controller. It must support MDP.
EtherNet/IP	Ethernet Industrial Protocol Open standard for industrial networks supporting cyclic and acyclic message transmission and operating on standard Ethernet communication chips and physical media.
Ethernet-Frame	Every Ethernet frame (data packet) comprises sender address (source) and recipient address (destination). When receiving a frame, the recipient's receiving unit compares the MAC destination address against its own MAC address. The frame content is only passed to the higher level if the addresses match. If they don't, the frame is discarded.
FE	Functional earth
FMMU	Fieldbus Memory Management Unit
FoE	File access over EtherCAT
IGMP	Internet Group Management Protocol (IGMP) is a network protocol of the Internet protocol family to organize multicast groups. IGMP uses Internet Protocol (IP) as a part of IP on all hosts supporting IP multicast reception.

Term	Significance
IIoT	The Industrial Internet of Things (IIoT) is the industrial version of the Internet of Things (IoT). In contrast to the IoT, it does not represent consumer-oriented concepts, but focuses on the application of the Internet of Things in the manufacturing and industrial environment.
IN	Input
I&M data	For identification and maintenance (I&M), data records (data structures) have been defined for PROFIBUS, which must be implemented for all devices with DP-V1. These data structures are used to uniquely identify the field device and facilitate maintenance.
IO-Link IOL	Standardized communication system for connecting intelligent sensors and actuators to an automation system
IRT	Isochronous real time/protocol for clock-synchronous activation of data and functions on different devices.
IP	Internet Protocol Protocol used for data transmission within a network, e.g. from one computer to another within the internet or intranet. Every computer in the network is unambiguously identified by its IP address. In data transmission from one computer to another, data is broken down into small packets of information, each including the addresses of both sender and recipient. These packets may arrive at their destination in different ways via the network and also in different order. A specific protocol, the so-called Transmission Control Protocol [TCP] restores the correct packet order.
IP67	Ingress protection according to DIN EN 60529
IP address	Address for identification in an Ethernet network
LED	Light Emitting Diode
LNK/ACT-LED	Link/Activity LED for signaling Ethernet communication.
MAC address	Media Access Control Address Hardware address of network components used for unambiguous identification within the network.
MDP	Modular Device Profile (Modular device profile)
MQTT	Client-server protocol
MRP	Media Redundancy Protocol/A protocol for the management of ring topologies in a production plant. It is used to increase the availability of devices in the network.
n.c.	Not connected
ODVA	ODVA is an international association for open and compatible information and communication technologies in automation technology. e.g. EtherNet/IP, DeviceNet, CompoNet and ControlNet,....
OUT	Output
PDO	Process data objects are user data expected in the application or transmitted to slave.
PELV	Protective Extra Low Voltage
Power LED	LED for signaling the power supply
PROFINET	Process Field Network

Term	Significance
PROFenergy	PROFINET profile for energy management in production plants
PQI	The port qualifier information (PQI) provides status information about the IO-Link port or the device status.
RPI	Requested packet interval The interval at which the EtherNet/IP target is transmitting process data to scanner.
SDO	Service Data Objects
SELV	Safety Extra Low Voltage with safe isolation.
Shared Device (SD)	Protocol extension of a PNIO device to establish simultaneous communication relationships with several PNIO controllers.
SNMP	Simple Network Management Protocol/Protocol for simple monitoring and control of various network participants.
PLC	Programmable Logic Controller
UA	Actuator voltage
US	Sensor voltage
Validation IO-Link	Check for compatibility or identity of a connected IO-Link device.

