

## Quickstart

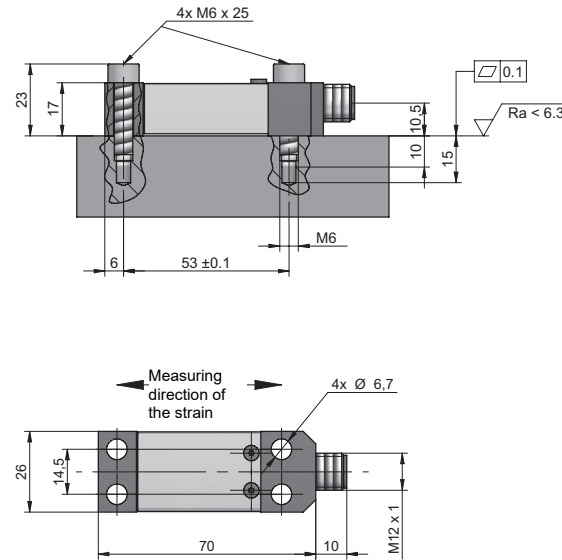

**DST53-ZxxxU**  
Strain sensor with voltage output

### Dimensional drawing



### Applicable documents

- Download at [www.baumer.com](http://www.baumer.com):
  - Data sheet
  - EU conformity declaration
- As a product insert:
  - General information insert (11042373)

### Scope of delivery

- 1 x sensor
- 4 x screws M6x25, quality 12.9

### Structure

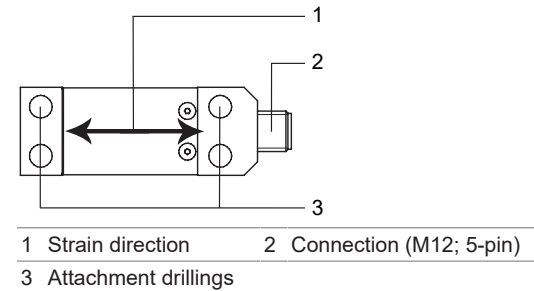

### Functionality

The sensor is screwed to a machine element and measures the applied strain. Changes to the strain are measured by resistance strain gauges and converted into an electric signal. When experiencing tensile force the sensor will generate a positive signal, when experiencing compression a negative signal. The integrated amplifier outputs an analog voltage signal.

### FAQ

#### The sensor does not output a stable signal. What is the reason for this?

The sensor is not screwed on tightly. To obtain stable measurement results, the sensor must be firmly screwed onto a machine element.

## EN

### Baumer Electric AG

Hummelstrasse 17  
CH-8501 Frauenfeld, Switzerland  
☎ +41 (0) 52 728 11 55  
info@baumer.com

For further Baumer contacts go to:  
[www.baumer.com](http://www.baumer.com)

Right of modifications reserved  
8/23/2022, 81376278, V2  
ID 9007199537184651

### Connection diagram

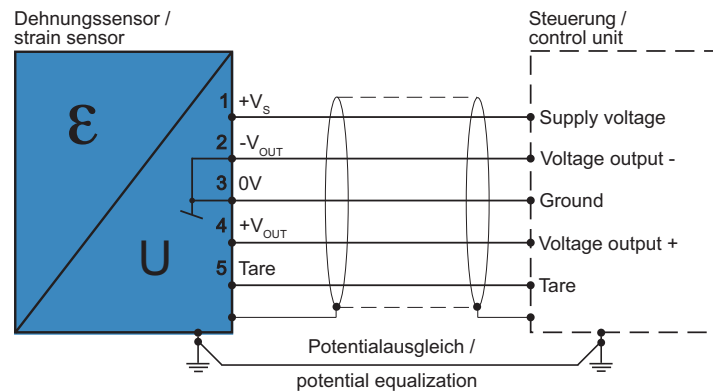

Output signal:  $V_{OUT} = \pm 10 \text{ V}$   
Taring function enabled: 5 ... 30 VDC  
Operating voltage range:  $+V_s = 18 \dots 30 \text{ VDC}$

Disconnect the system from power before connecting the device. Power supply according to UL 1310, Class 2 or external protection via a UL-approved or listed fuse with max. 100 W/Vp or max. 5 A below 20 V.  
Note on electromagnetic compatibility: Shielded connection cable is recommended. Ground the cable shield on both sides over a large surface and ensure potential equalization.  
Connection cable length max. 20 m.

### Pin assignment

1	+Vs
2	-V <sub>OUT</sub>
3	GND
4	+V <sub>OUT</sub>
5	Taring
Housing	Shield

## Preparing the installation

Baumer recommends mounting on structures with blind holes. For thin structures, the sensor can also be mounted with through holes. In this case, make sure that the structure is sufficiently rigid.

### NOTICE

**The sensor supplies imprecise measurement results if the measuring surface is soiled or if the sensor is installed incorrectly.**

- Prevent soiling from grease and oil.
- Mount the sensor on a machined, flat surface.
- Observe the surface roughness.

### Mounting option with blind holes

*Instruction:*

- Check the flatness tolerance.  
Flatness tolerance  $\leq 0.1$  mm

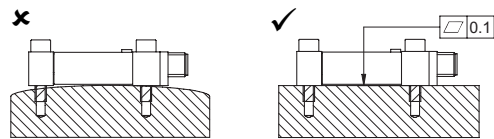

- Check the surface roughness.  
Surface roughness  $\leq 6.3$   $\mu\text{m}$

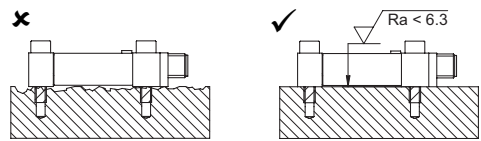

- Drill 4 threads into the machine element. Make sure to drill the holes perpendicular to the contact surface of the sensor.
  - Drill hole spacing:  $53 \text{ mm} \pm 0.1$ ;  $14.5 \text{ mm} \pm 0.2$
  - Depth of drill holes:  $\geq 15$  mm
  - Depth of thread:  $\geq 10$  mm

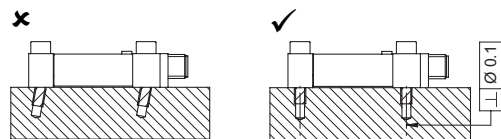
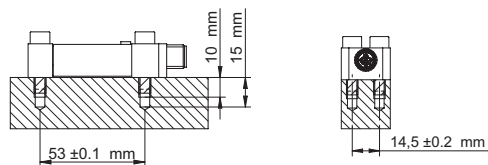

### Mounting option with through holes

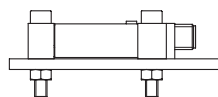

## Mounting the sensor

### INFO

The supplied screws (M6×25) are designed for mounting on steel. Use longer screws (M6×30) for mounting on light or non-ferrous metals.

The following describes mounting on steel:

*Instruction:*

- Make sure that the machine element is not loaded.
- Screw in the screws hand-tight.
- Tighten the screws (hexagon socket SW5) cross-wise in 2 stages with a torque wrench to a tightening torque of 18 Nm.

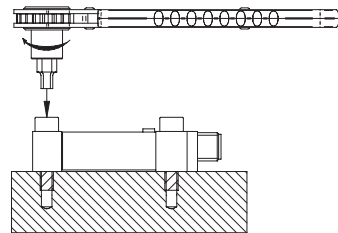

## Putting the sensor into operation for the first time

For commissioning, the sensor is connected directly to the controller. The output signal is an analog signal and is proportional to the strain.

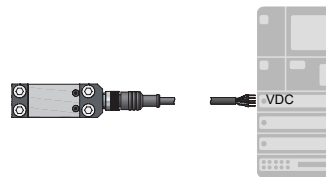

*Instruction:*

- To minimize the effect of settlement, fully load the sensor 10 times, if possible.
- With the power supply switched on, allow the sensor to warm up for 5 minutes to stabilize the zero point.
- Tare the sensor at zero load to compensate for signal changes due to mounting.

*Result:*

- ✓ The sensor is ready for operation.

## Operation

### Taring the sensor

Tare the sensor cyclically when unloaded to compensate zero drift or temperature influence.

*Instruction:*

- Make sure that the sensor is not subject to any change in strain.
- Make sure the machine element is at the correct zero position.
- Tare the sensor at zero load (voltage signal *High*).

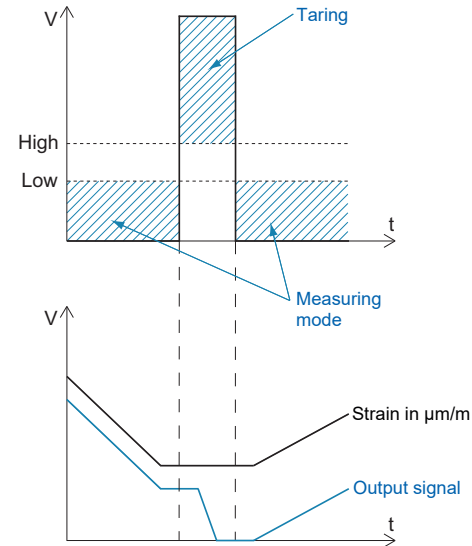

### NOTICE

#### Unintended taring during operation

- To prevent unintended taring during operation, the voltage at *Tare Pin* must be kept at a defined low limit (e.g. *Tare Pin* assigned to *Ground*).

### Preventive maintenance

The sensor is maintenance-free. No special preventive maintenance is required. Regular cleaning and regular checking of the plug connections are recommended.